

TX2000

Intelligent pH/ORP Transmitter

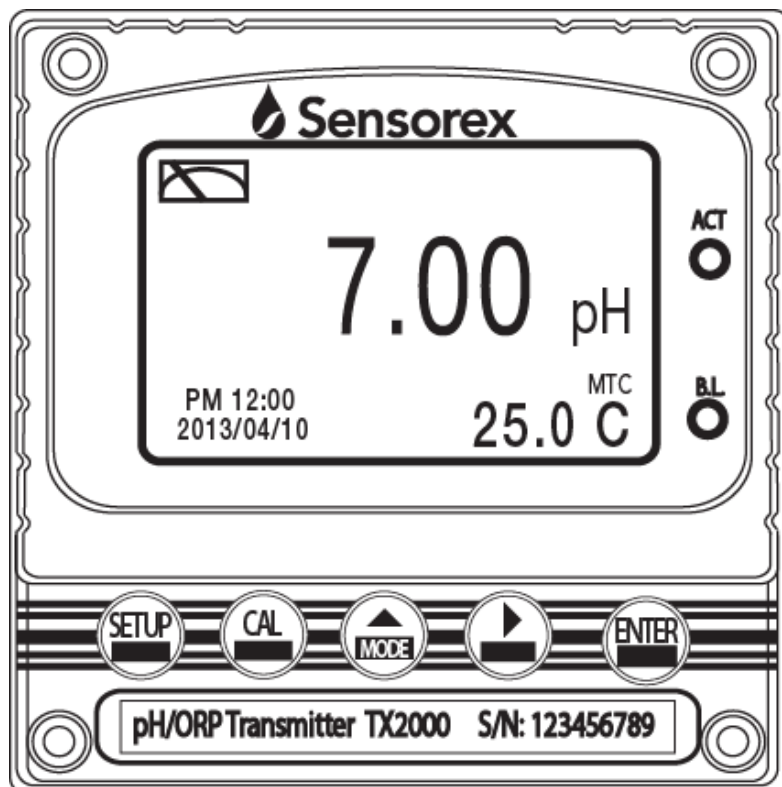

Thank you for purchasing Sensorex products. In order to continually improve and enhance the transmitter's function, Sensorex reserves the right to modify the content and icon display of the product. The actual situation is subject to the instrument without notice. The operation manual is only provided for function and installation description. Sensorex Corporation is not liable for any person or entity for any direct or indirect loss or damage due to improper usage of this product. If you have any questions or find any omissions, or mistakes in this operation manual, please contact Sensorex Corporation.

Precautions for installation

Wrong wiring will lead to breakdown or electrical shock of the instrument, please read this operation manual clearly before installation.

- Make sure to remove AC power from the transmitter before wiring input, output connections, and remove it before opening the transmitter's housing.
- The installation site of the transmitter should be good in ventilation and avoid direct sunshine.
- The material of signal cable should be special coaxial cable. Strongly recommend using our coaxial cable. Do not use normal wires instead.
- Avoid electrical surge when using power. Especially when using three-phase power, use ground wire correctly.
- The internal relay contact of the instruments is for alarm or control function. Due to safety, **please must connect to external relays which can stand enough ampere to make sure the safety operation of the instrument.** (Please refer to chapter 3.7 "Illustration of electrical connection")

CONTENTS

Precautions for installation

Brief Instruction	1
1. Specifications	4
2. Assembly and installation	
2.1 Transmitter installation.....	5
2.2 Illustration of panel mounting.....	5
2.3 Illustration of wall mounting and pipe mounting.....	6
2.4 Assembly of electrode and housing.....	6
2.4.1 Cable set-up.....	6
2.4.2 Assembly of immersive electrode holder and junction box.....	7
2.5 Illustration and description of junction box (not shown).....	9
3. Overview of Intelligent pH/ORP transmitter TX2000	
3.1 Illustration of rear panel.....	10
3.2 Illustration of terminal function.....	10
3.3 Description of terminal function.....	11
3.6 Typical wirings.....	14
3.7 Illustration of electrical connection.....	14
4. Configuration	
4.1 Illustration of front panel.....	15
4.2 Keypad.....	15
4.3 LED indicators.....	15
4.4 Display.....	16
5. Operation	
5.1 Measurement mode.....	17
5.2 Set-up menu.....	17
5.3 Calibration menu.....	17
5.4 Shortcuts.....	17
5.5 Default value	
5.5.1 Setting default value.....	17
5.5.2 Calibration default value.....	17
6. Settings	
Block diagram of settings.....	18
6.1 Entry of set-up menu.....	20
6.2 Security code of settings(Code).....	21
6.3 Language.....	22
6.4 Measurement parameters(Mode).....	23
6.5 Multi-point calibration(Multi-Cal).....	24

6.6	Temperature.....	25
6.7	Relay 1.....	26
6.8	Relay 2.....	27
6.9	Clean.....	28
6.10	Analog output 1 (pH/ORP).....	29
6.11	Analog output 2 (temperature).....	30
6.12	Date/Time (Clock).....	31
6.13	Sample average of measurements (Digital filter).....	32
6.14	Backlight settings.....	33
6.15	Contrast settings.....	34
6.16	Automatically back to measurement mode(Return).....	35
7.	Calibration	
	Block diagram of Calibration.....	36
7.1	Entry of calibration menu.....	37
7.2	Security password of calibration.....	38
7.3	pH calibration.....	39
	7.3.1 TECH mode	39
	7.3.2 NIST mode	39
	7.3.3 Any mode	39
	7.3.4 Definition of calibration parameter.....	40
	7.3.5 TECH, NIST buffer Calibration.....	41
	7.3.6 Any Calibration.....	42
7.4	ORP calibration.....	43
7.5	Automatically back to measurement mode(Return)	
8.	Error messages (Error code).....	45
9.	Maintenance.....	46
Appendix	47

1. Specifications

Model		TX2000
Measuring modes		pH / ORP / Temp.
Ranges	pH	-2.00~16.00 pH
	ORP	-1999~1999 mV
	Temp.	-30.0~130.0 °C
Resolutions	pH	0.01 pH
	ORP	1 mV
	Temp.	0.1 °C
Accuracy	pH	±0.01 pH (± 1 Digit)
	ORP	±0.1% (± 1 Digit)
	Temp.	±0.2°C (± 1 Digit), equipped with temperature error modification function
Temperature Compensation		NTC30K/ PT 1000 auto temperature compensation
		Manual adjustment temperature compensation
Calibration mode		TECH, NIST, Any Buffers, up to three point calibration
Ambient Temp.		0~50°C
Storage Temp.		-20~70°C
Input Impedance		> 10 ¹² Ω
Display		Large LCM with auto-sense backlight sensor & contrast function. Text mode.
Analog output 1		Isolated DC 0/4~20mA corresponding to main measurement, max. load 500Ω
Analog output 2		Isolated DC 0/4~20mA corresponding to Temp., max. load 500Ω
Settings	Contact	RELAY contact, 240VAC 0.5A Max.(recommend)
	Activate	Hi/Lo. Hi/Hi. Lo/Lo selectable two limited programmable, ON/OFF
Wash		RELAY contact: ON 0~99min. 59sec. / OFF 0~999hr 59min.
Voltage Output		DC±12V , 1W max.
Protection		IP65(NEMA 4X)
Power Supply		100V~240VAC±10% , 4W max. , 50/60Hz
Installation		Wall or Pipe or Panel Mounting
Dimensions		3.78”(96mm) × 3.78”(96mm) × 5.20”(132mm) (H×W×D)
Panel Cut Out Dimensions		3.66”(93 mm) × 3.66”(93 mm) (H×W)
Weight		1.1lb(0.5Kg)

Note: The specifications are subject to change without notice.

2. Assembly and installation

2.1 Transmitter installation: This Transmitter can be installed through panel mounting, wall mounting and 2" pipe mounting.

Installation of panel mounting: First, prepare a square hole of 3.66" (93mm) x 3.66" (93mm) on the panel box, and then insert the controller directly into the panel box. Insert the mounting bracket from the rear, and until it is fixed into the pickup groove.

2.2 Illustration of panel mounting

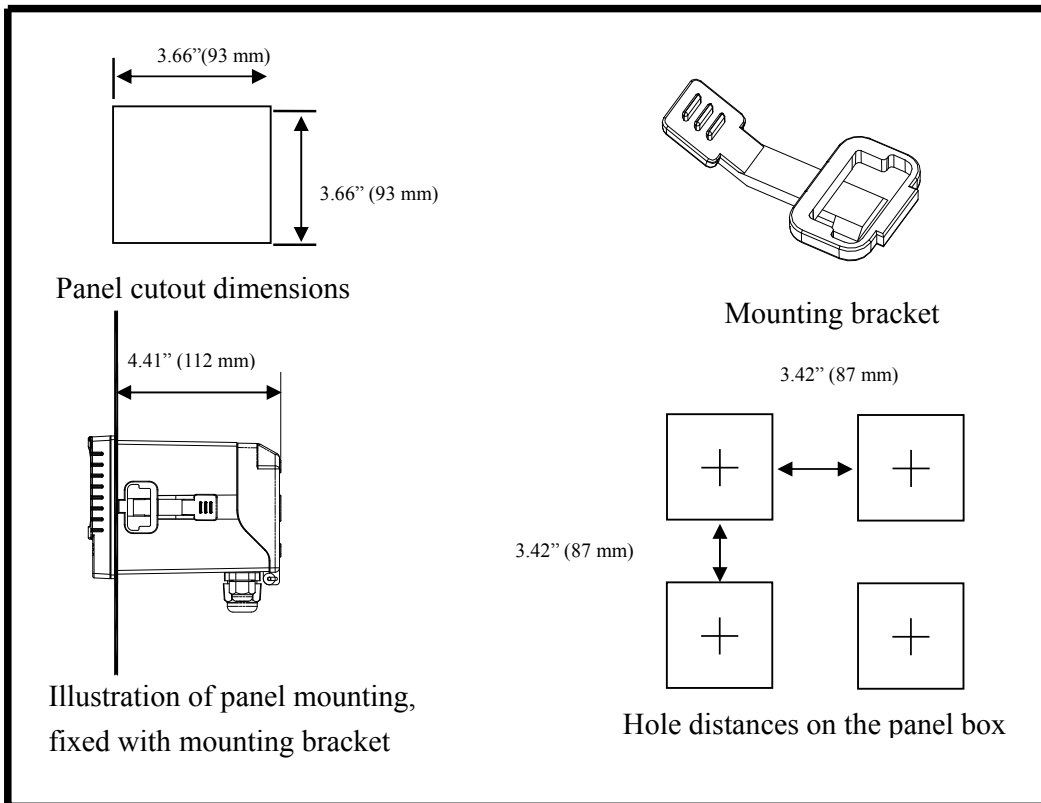

2.3 Illustration of wall mounting and pipe mounting

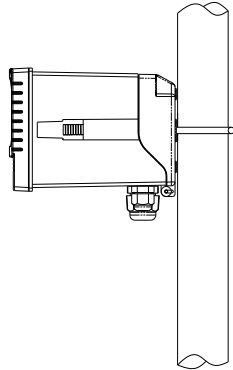

Installation of pipe mounting
Fixed with U-shaped pipe clamp.
(Optional, Order Number: 5333027)

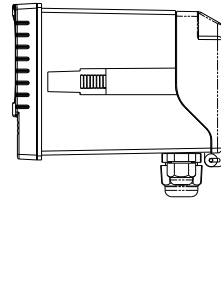

Installation of wall mounting
Fixed with 4 x M4 screws

Penetrate the two prepared holes in the rear cover and fix the U-shaped pipe clip, and then install two waterproof squeezed caps (the transmitter's standard accessory kit) into the holes from inner rear cover to prevent from the water vapor.

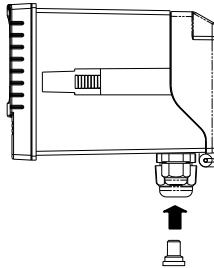

Insert the single hole rubber plug into the unused cable gland, and tighten up the cable gland to prevent from the penetration of water vapor.

2.4 Assembly of electrode and housing

2.4.1 Cable set-up

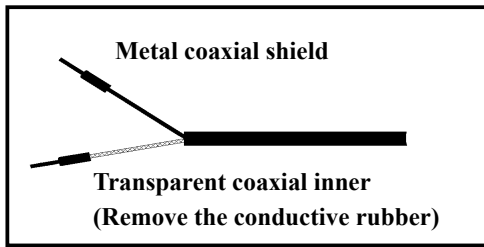

Set-up diagram of coaxial cable:

See the correct set-up method on the left:

Note: The black conductive rubber covering on the coaxial inner should be removed.

- Make sure to remove the conductive rubber or aluminum-foil layer between the electrode signal wire and the coaxial shield.
- Extend the cable to the transmitter without any joint except specific junction box. Connect the transparent coaxial inner directly to the Glass terminal on the back of transmitter, and metal connect coaxial shield to Ref. terminal.

2.4.2 Kopykopycm 'igh'dic pm

THIS PAGE LEFT
INTENTIONALLY
BLANK

THIS PAGE LEFT
INTENTIONALLY
BLANK

3. Overview of pH transmitter TX2000

3.1 Illustration of rear panel:

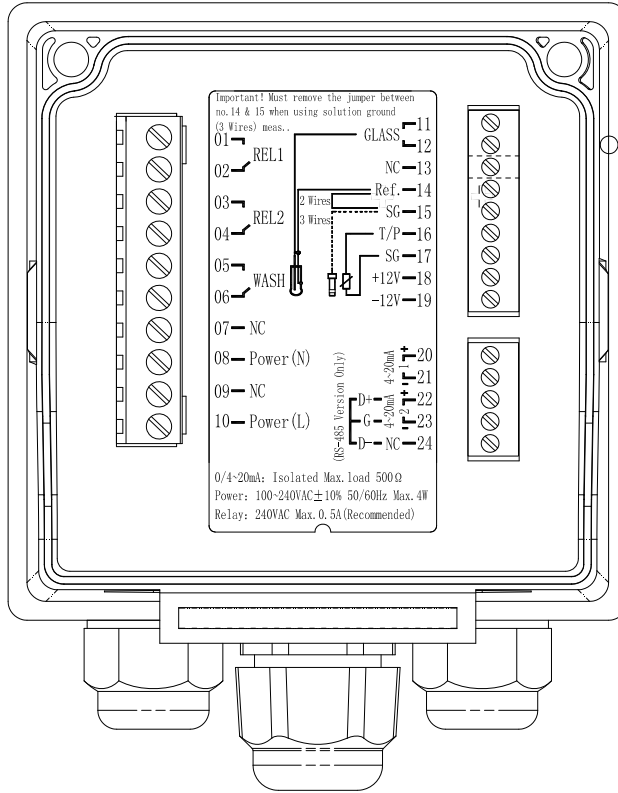

3.2 Illustration of terminal function:

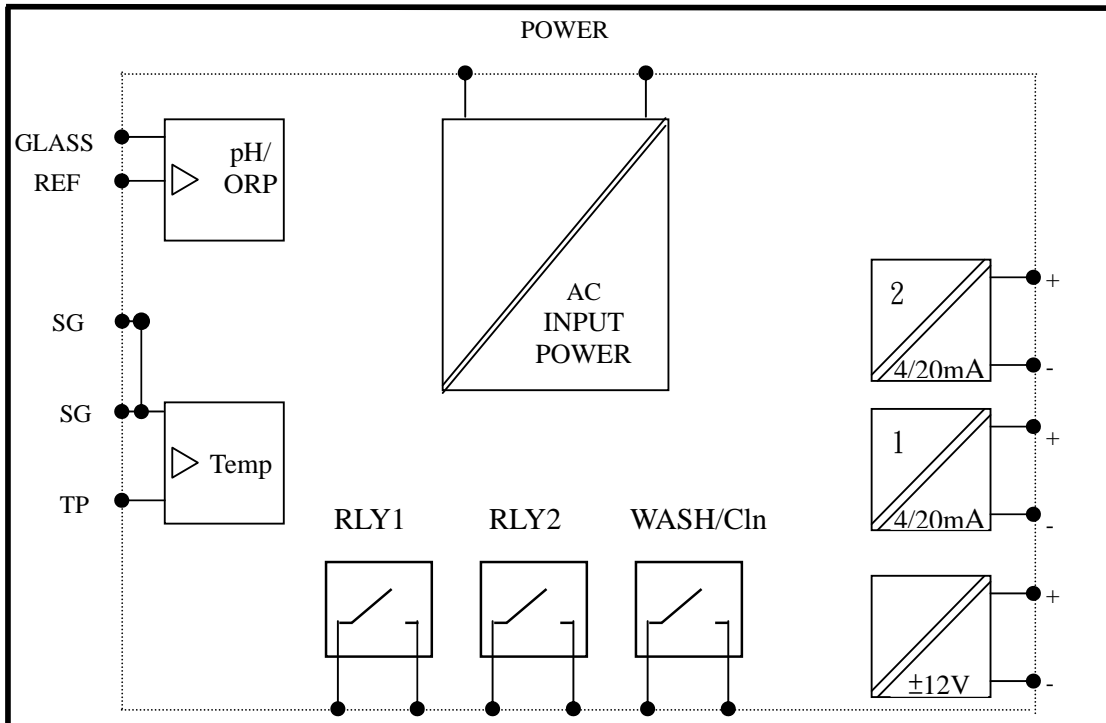

3.3 Description of terminal function:

- 0 1 ———— **REL1:** First alarm control, contact for an external relay
- 0 2 ———— **REL2:** Second alarm control, contact for an external relay
- 0 3 ———— **REL2:** Second alarm control, contact for an external relay
- 0 4 ———— **REL2:** Second alarm control, contact for an external relay
- 0 5 ———— **WASH:** Wash relay contact for an external relay
- 0 6 ———— **WASH:** Wash relay contact for an external relay
- 0 7 ———— **NC:** No connection
- 0 8 ———— **100~240VAC:** Power supply terminal
- 0 9 ———— **NC :** No connection
- 1 0 ———— **100~240VAC:** Power supply terminal
- 1 1 ———— **GLASS:** Coaxial inner wire of pH/ORP electrode signal wire
- 1 2 ———— **GLASS:** Coaxial inner wire of pH/ORP electrode signal wire
- 1 3 ———— **NC:** No connection
- 1 4 ———— **REF:** Coaxial shield of pH/ORP electrode signal wire
- 1 5 ———— **SG:** Solution ground wire. **If no solution ground, there should be a jumper between this terminal and REF (14). A short circuit bar is attached when shipped from the factory.**
- 1 6 ———— **T/P:** Connect with one of cable end of temperature probe
- 1 7 ———— **SG:** Connect with one of cable end of temperature probe
- 1 8 ———— **DC±12V :** Output terminal of direct current voltage ±12V
- 1 9 ———— **DC±12V :** Output terminal of direct current voltage ±12V
- 2 0 ———— **4~20mA +terminal :** Master measure current output terminal +, for external recorder or PLC control
- 2 1 ———— **4~20mA - terminal :** Master measure current output terminal -, for external recorder or PLC control
- 2 2 ———— **4~20mA + terminal/ D+(B) :** Temperature current output terminal +, for external recorder or PLC control (only applicable for TX2000); or RS-485 output D+(B) (only applicable for TX2000RS)
- 2 3 ———— **4~20mA - terminal G :** Temperature current output terminal -, for external recorder or PLC control (only applicable for TX2000); or RS-485 output GND (only applicable for TX2000RS)
- 2 4 ———— **NC / D-(A):** NC or RS-485 output D-(A) (only applicable for TX2000RS) or RS-485 output D-(A) (only applicable for TX2000RS)

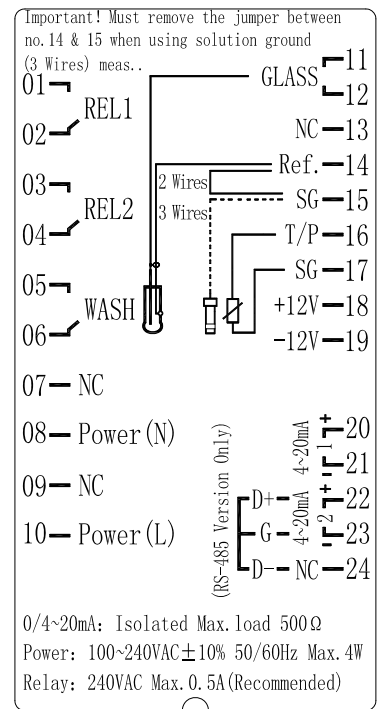

3.6 Typical wirings

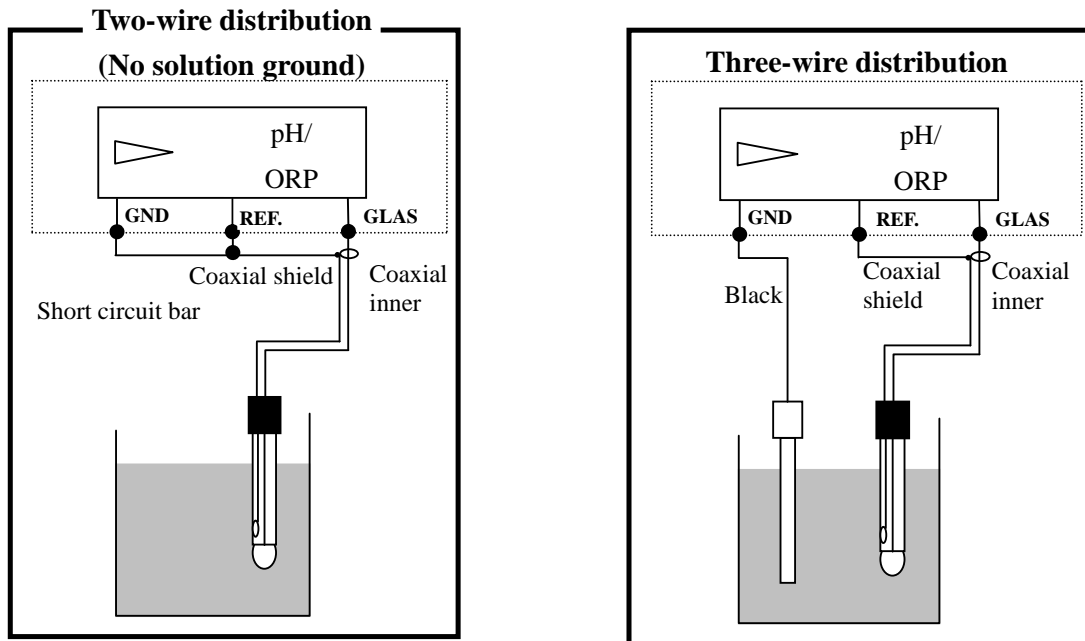

3.7 Illustration of electrical connection

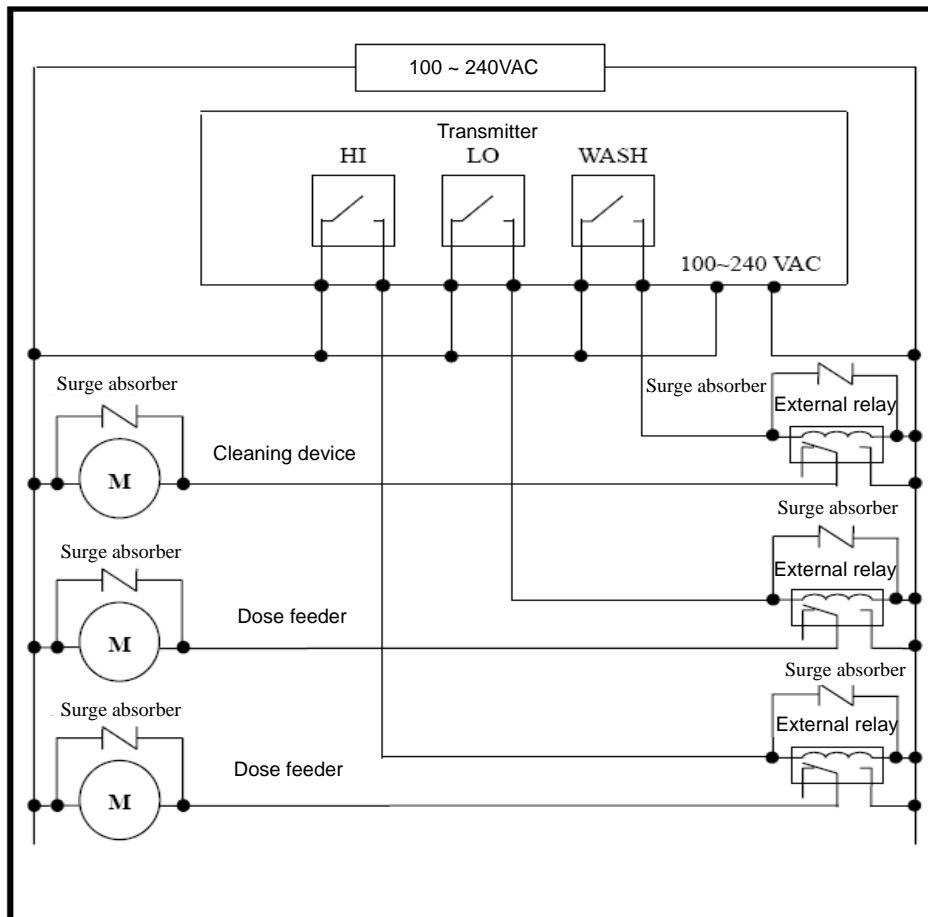

Note: The transmitter built-in miniature relays is necessary to be repaired and replaced by professional technicians. It is recommended to use an external relay (Power Relay) to activate the external equipments.



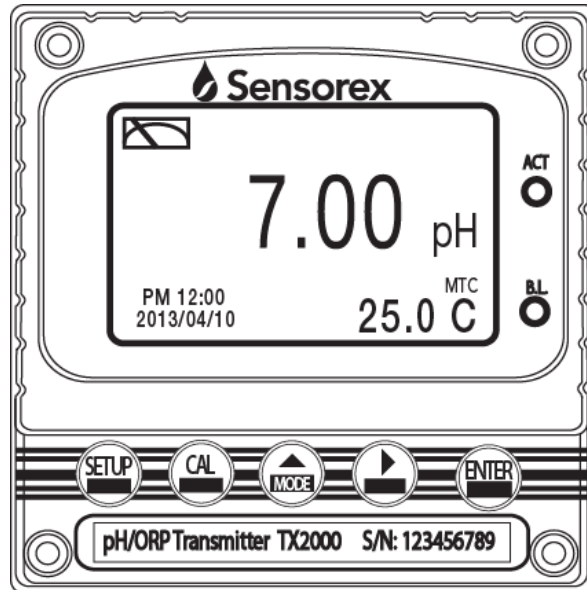

4. Configuration:

4.1 Illustration of front panel:



4.2 Keypad:

In order to prevent inappropriate operation by others, before the parameter setting and calibration, the operation applies multi-keys, and coding protection if necessary. Description of the key functions is in the following:

-  : In the parameter set-up mode, pressing this key allows you exit parameter set-up mode and back to Measurement mode.
-  : In the Calibration mode, pressing this key allows you exit Calibration mode and back to Measurement mode.
-  :
 1. In the parameter set-up mode and Calibration mode, pressing this key to select leftward or change to another page.
 2. When adjusting value, press this key to increase the value.
-  :
 1. In the parameter set-up mode and Calibration mode, pressing this key to select rightward or change to another page.
 2. When adjusting value, press this key to decrease the value.
-  : Key for confirmation; pressing this key is essential when modifying data value or selecting the parameter setting items in the window.

4.3 LED indicators:

ACT: Washing device operation indicator and controlling operation indicator (Relay 1, Relay 2)

B.L. : Light sensor; in the automatic display backlit mode, the lamp will light or go out as the change of environmental brightness.

4.4 Display:

1. When the function is activated, the display shows and twinkles the description, "Clean Running". At the same time, the ACT indicator LED lights up, and the transmitter automatically turns off Relay 1 and Relay 2 function. After finishing cleaning, the Relay 1 and Relay 2 will automatically back to normal status.
2. When Relay 1/Relay 2 which is set in high setting point is in action, the display shows and flashes the description, "REL 1-HI/REL 2-HI", and ACT indicator LED lights up. When Relay 1/Relay 2 which is set in low setting point is in action, the display shows and flashees the description, "REL 1-Lo/ REL 2-Lo", and ACT indicator LED lights up.
3. When the Analog 1 current output exceeds the upper/lower limitation, the display flashes "pH-mA ▲ / pH-mA ▼" or "ORP-mA ▲ / ORP-mA ▼".
4. When the Analog 2 current output exceeds the upper/lower limitation, the display flashees "°C-mA ▲ / °C-mA ▼".

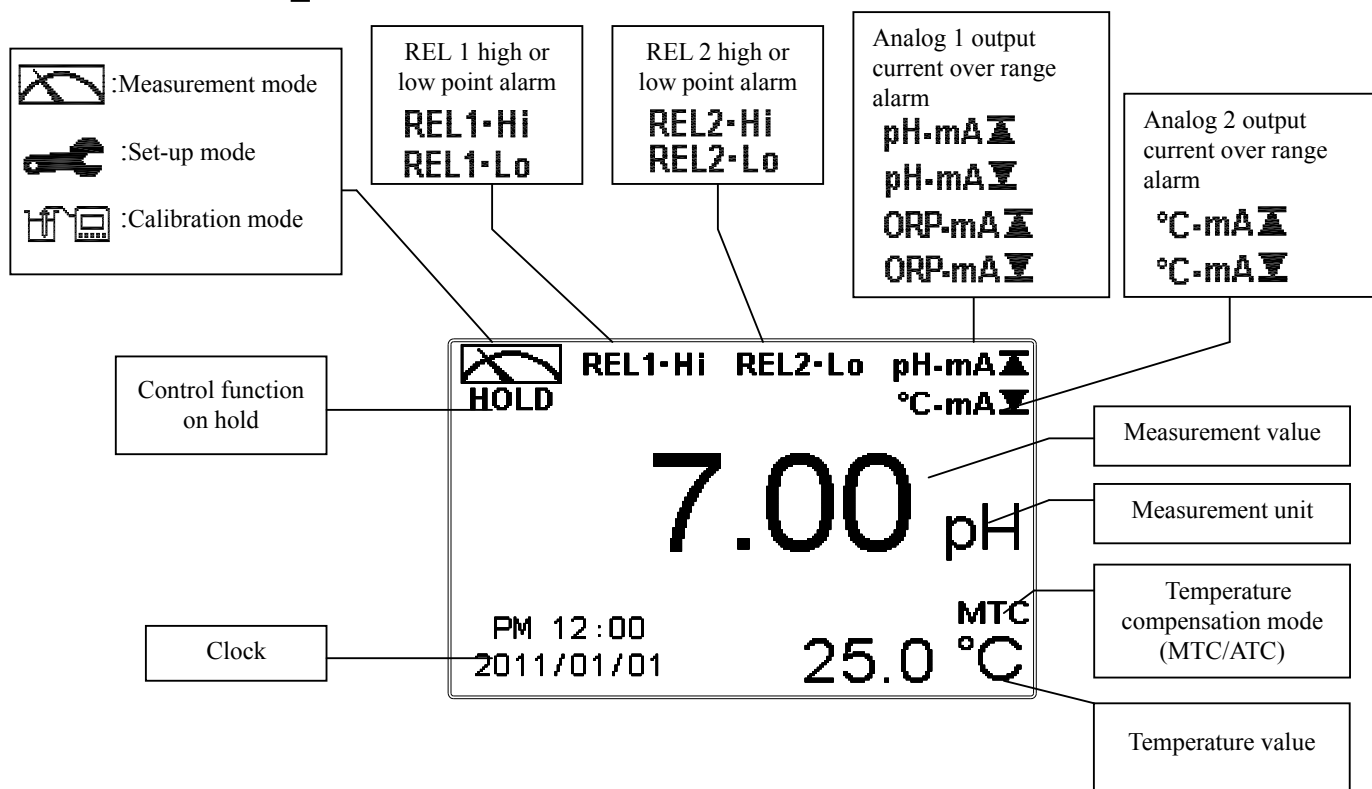

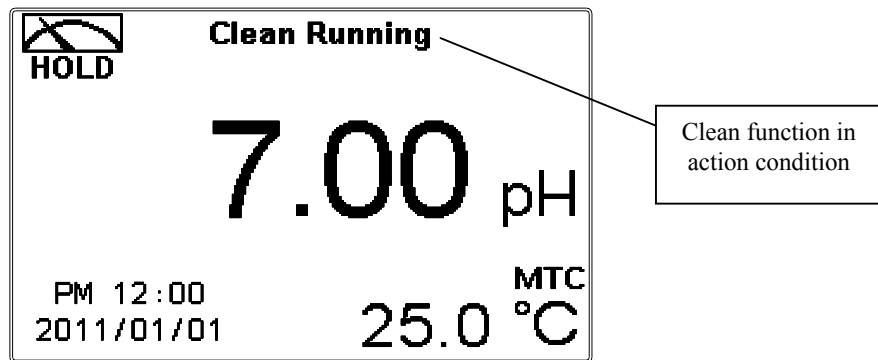



- Note: The “HOLD” warning text appears when clean function is activated, or when entering setup menu, or when entering calibration menu. Under HOLD status, the corresponding display and output are as follows:
1. Both Relay 1 and Relay 2 are not functioning. If enter setting menu or calibration menu under clean status, the instrument will stop clean status automatically.
 2. The current output which is corresponding to measurement value remains at the last output value before HOLD status.

5. Operation

5.1 Measurement mode:

After all electrical connections are finished and tested, connect the instrument to the power supply and turn it on. The transmitter will automatically enter measurement mode with the factory default settings or the last settings from user.



5.2 Set-up menu:

Please refer to the set-up instructions in Chapter 6. Press  and  simultaneously to enter into set-up menu. Press  go back to measurement mode.

5.3 Calibration menu:

Please refer to the calibration instructions in Chapter 7. Press  and  simultaneously to enter into calibration menu. Press  to go back to measurement mode.

5.4 Shortcuts:

In the measurement mode, if selecting MTC for temperature compensation mode, you may press  and  adjust MTC temperature value.

5.5 Default value:

5.5.1 Setting default value:

Measurement mode: pH

Multi-Cal : 2 points pre-setting

Temperature compensation: MTC 25°C

Relay 1: High point alarm: AUTO, SP1= 10.00 pH, Hys= 0.10 pH

Relay 2: Low point alarm: AUTO, SP2 =04.00 pH, Hys= 0.10 pH

Wash time: OFF

Analog 1 current output (pH/ORP): 4~20 mA, 0.00~14.00pH

Analog 2 current output (Temp): 4~20 mA, 0~100.0°C

Digital filter: 5

Backlight setting: Off

Code set-up: OFF

Date & Time: 2012/1/1 00:00:00

Contrast: 0

Auto back: Auto, 3 minutes

5.5.2 Calibration default value:

Asy: 0 mV

Slope: -59.15 mV/pH @ 25.0°C

Calibration type: TECH-No Cal

Calibration value: None data

Auto back: Auto, 3 minutes



Note: The factory default of calibration presetting is “No Cal”, and the calibration value is “None”. This means that the user has not calibrated the sensor with the transmitter yet. After finishing every calibration, the display shows the calibration type and the calibration value. If the equipment have not been calibrated yet, the measurement takes pre-set Asy and Slope into calculation. The factory default values are subject to change without notice.

Block diagram of setting-part 2

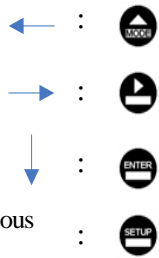
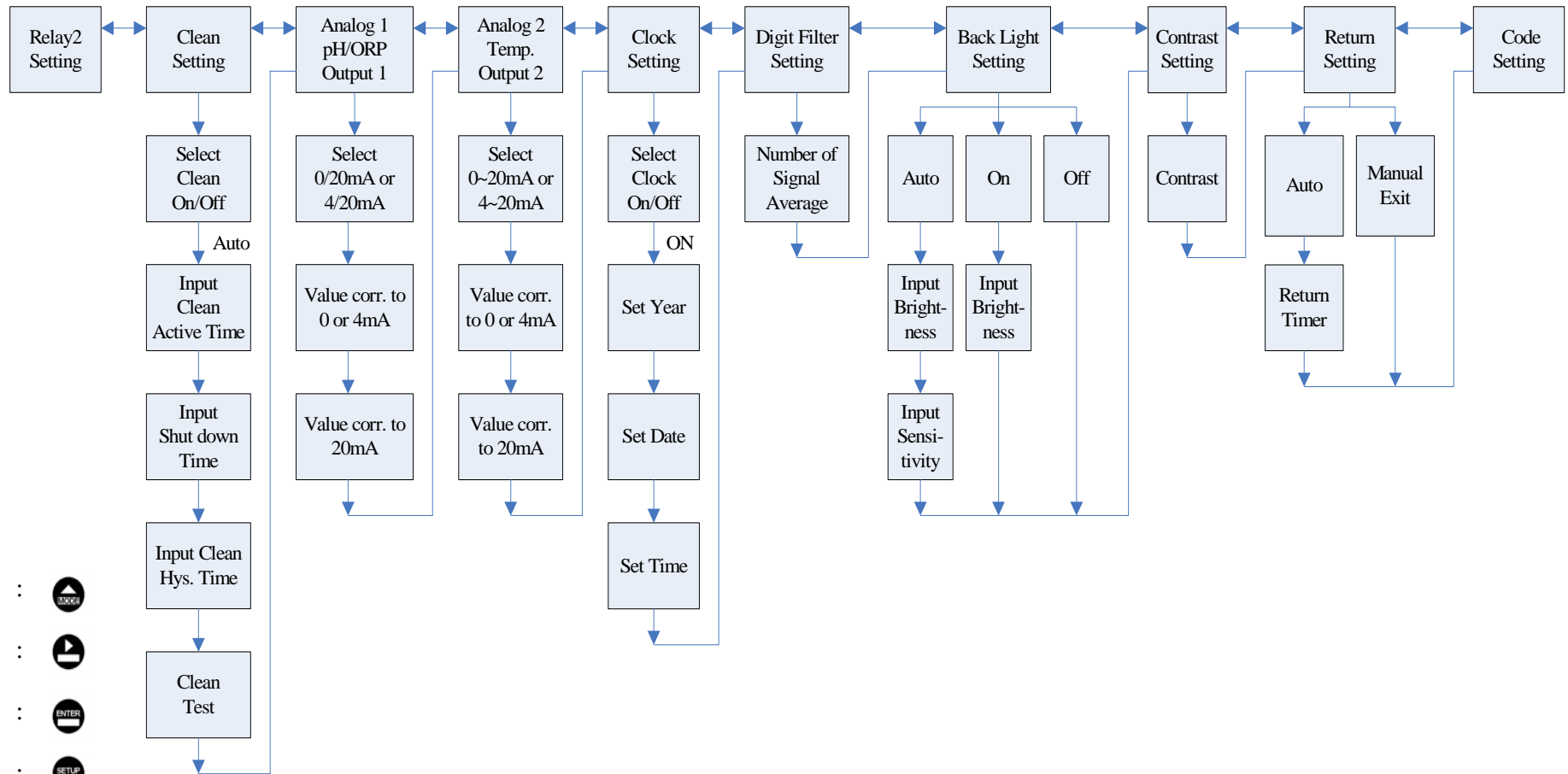
CONTINUED FROM
PREVIOUS PAGE



6.1 Entry of set-up menu

In the measurement mode, pressing the two keys  and  simultaneously allows you enter the overview of current setting, and press  to enter the set-up mode to modify the setting if necessary.

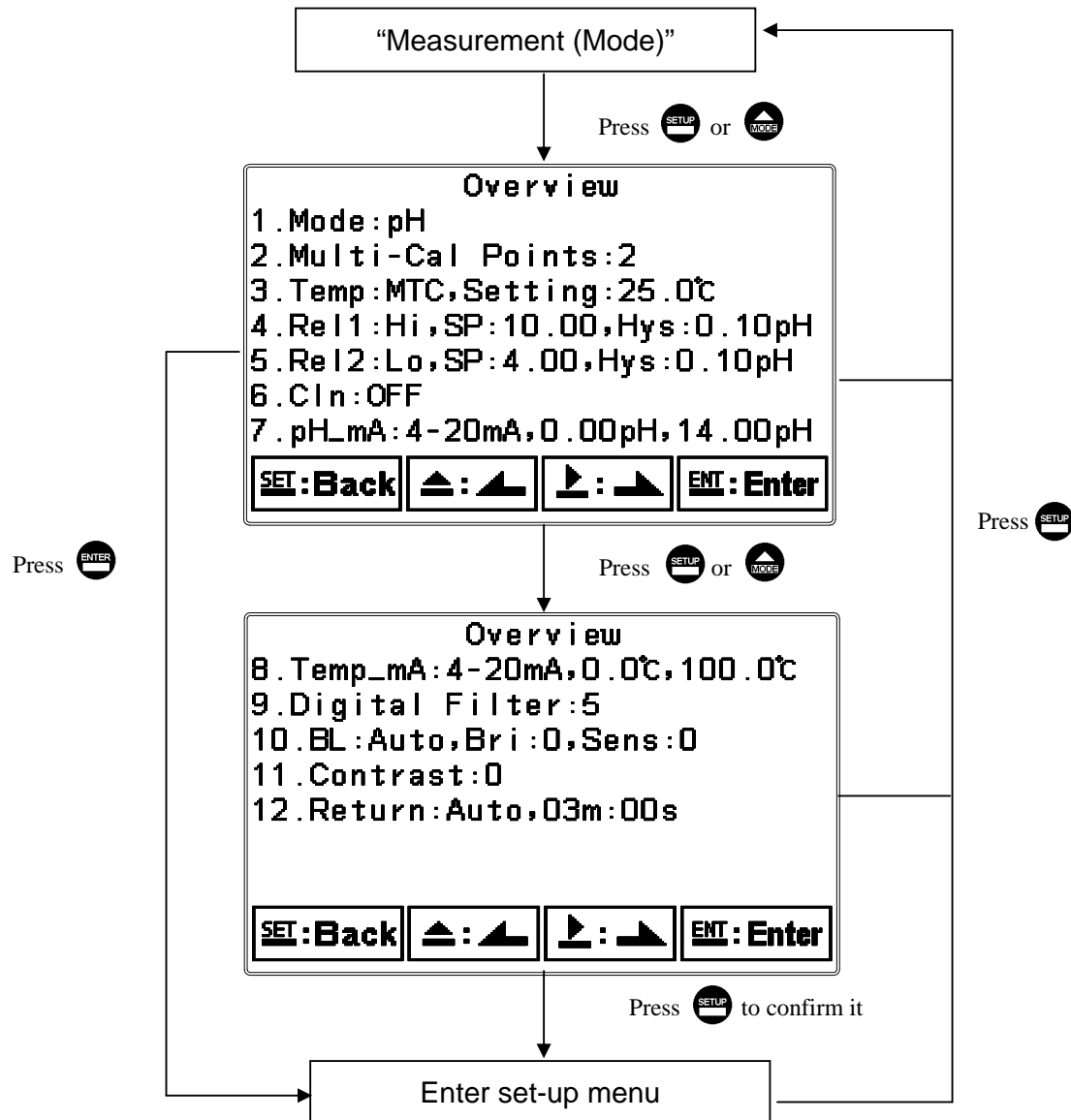

6.2 Security code of settings

After entering set-up mode, select “code” item, press  to enter into code procedure. **The code pre-setting is 1111.**

Note: The code of setting mode is prior to the code for calibration. That means that the code of setting mode can be used for the code of calibration mode.

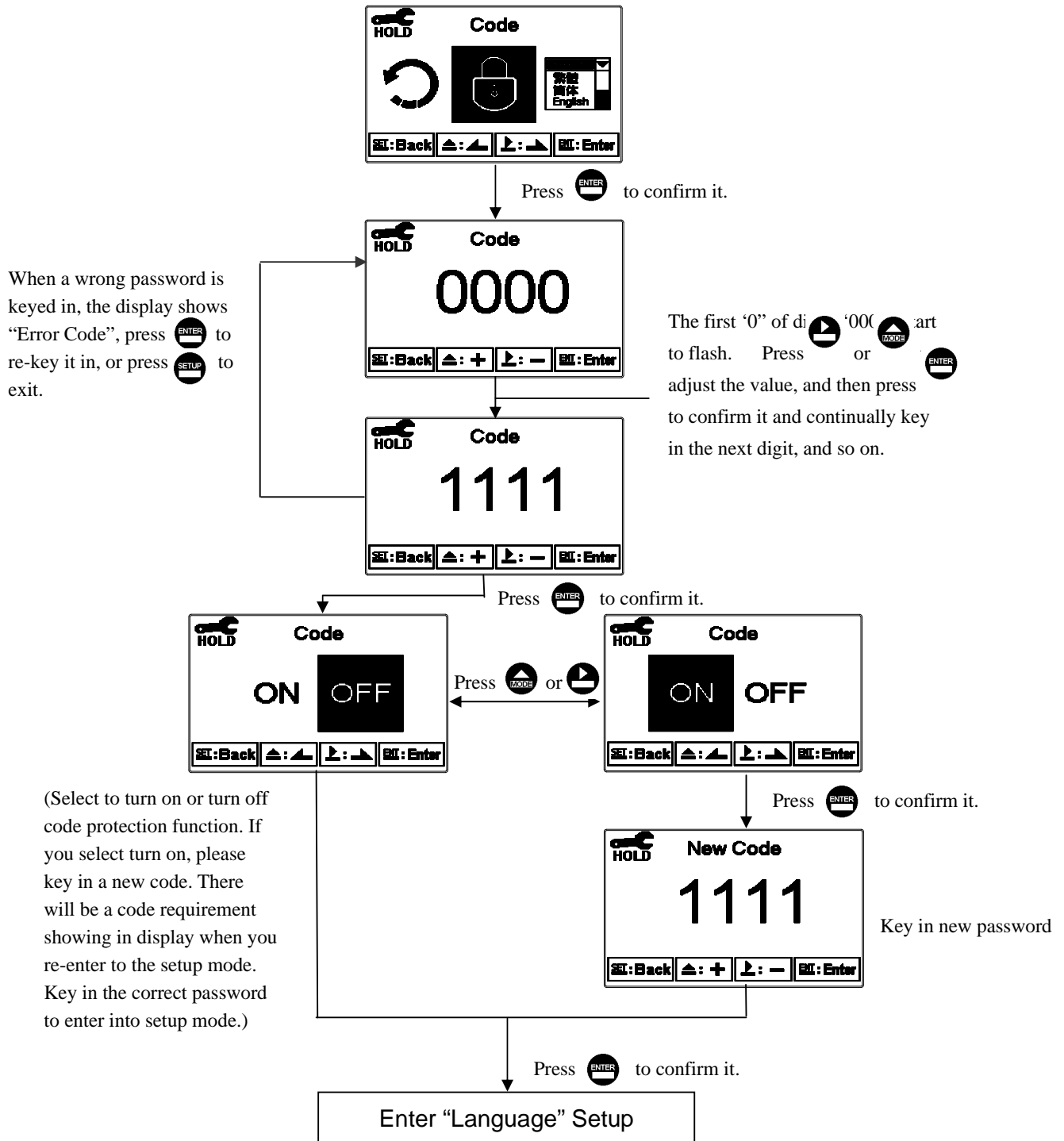

6.3 Language

Enter Language setup menu, select the system language from English, Traditional Chinese and Simplified Chinese.

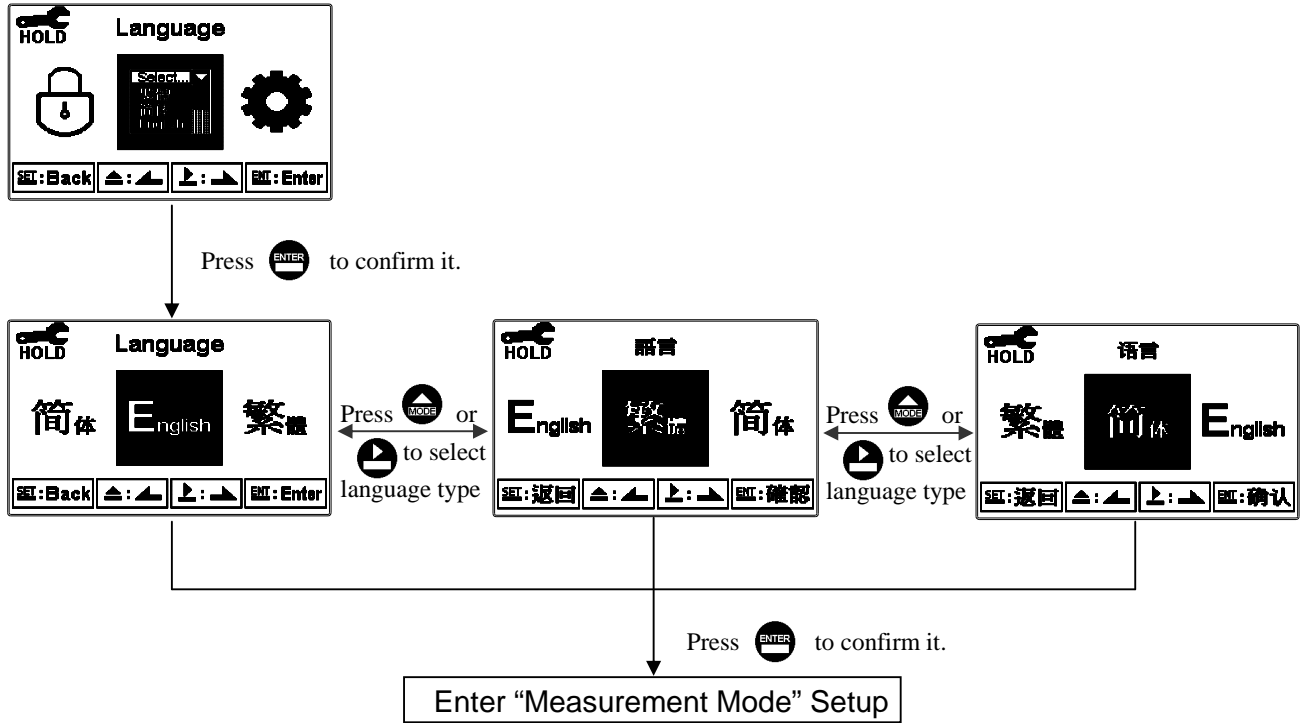

6.4 Mode

Enter setup of "Mode". Select between "pH" or "ORP" measurement.

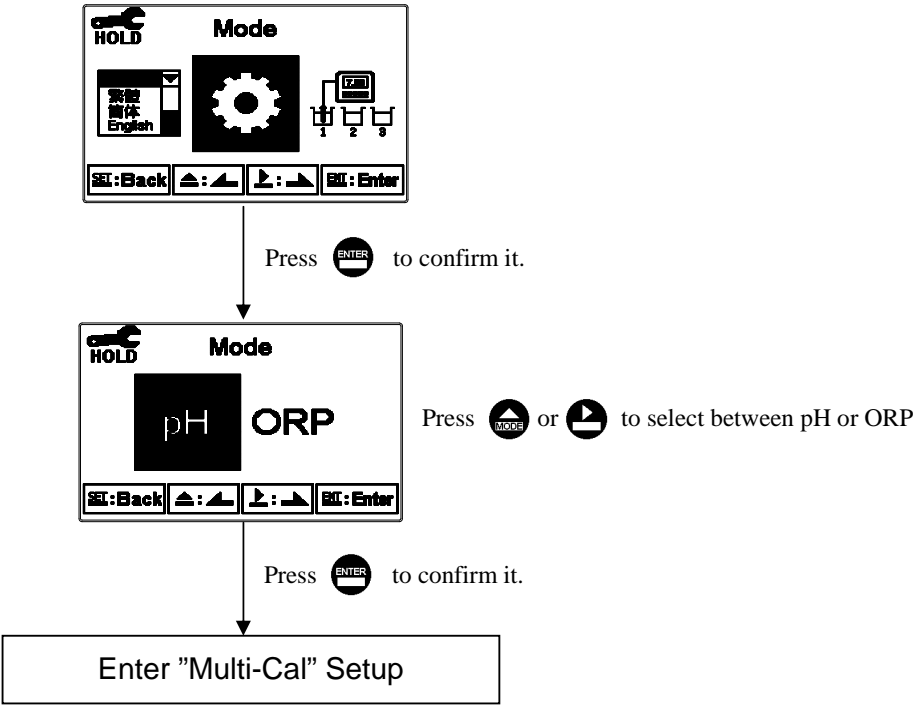

6.5 Multi-Cal

Enter setup of multi-points calibration to set the number of calibration points.

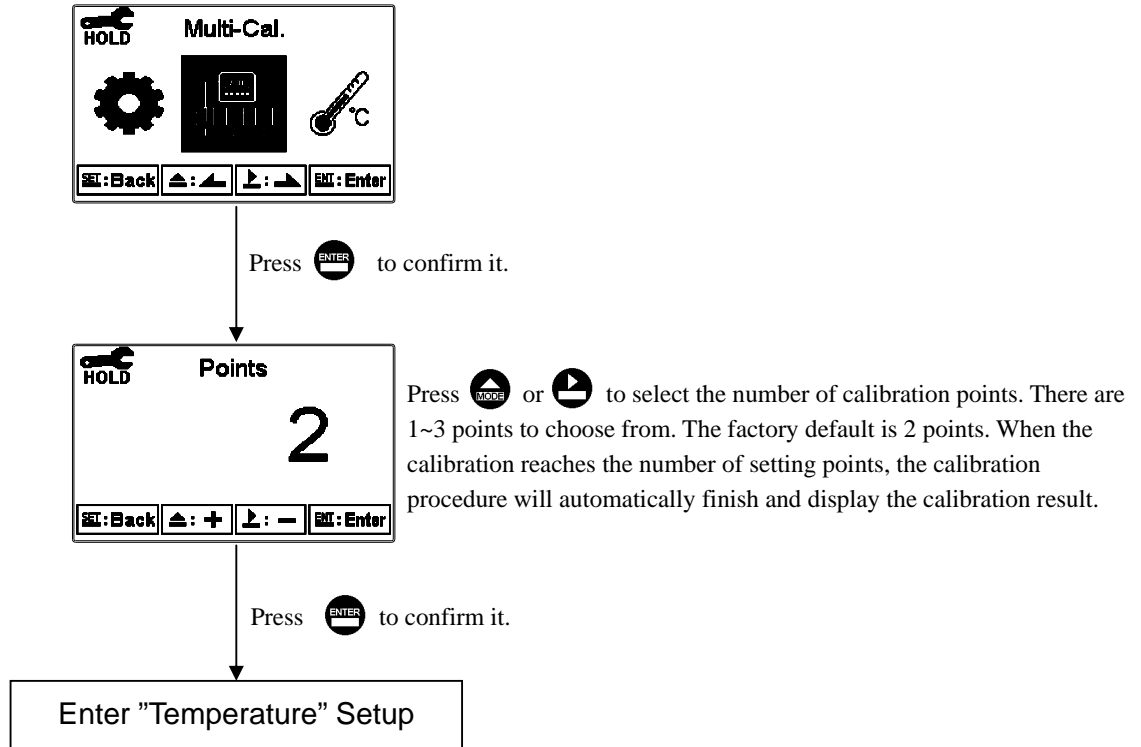

6.6 Temperature

Enter setup of “Temperature” to select temperature compensation mode. Select from NTC(NTC 30K), PTC(PT 1K) or MTC(Manual adjustment).

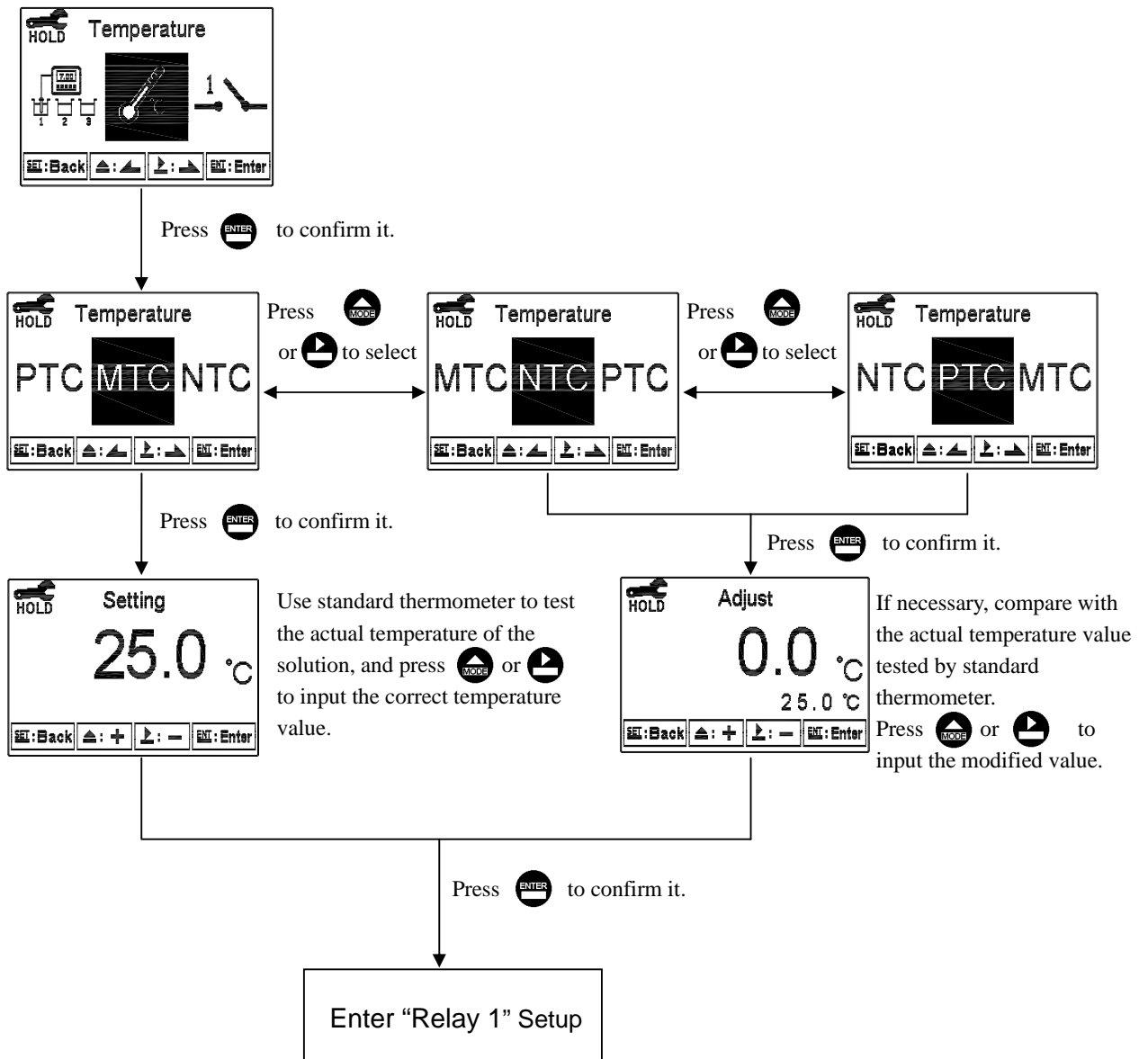

6.7 Relay 1

Enter setup of Relay 1. Select the item to turn on or turn off the relay 1 function. If you select to turn on the relay 1, then select for using relay 1 as “High set-point” alarm or “Low set-point” alarm. Set the value of set-point (SP) and Hysteresis (Hys.). The relationship between parameters can refer to an explanatory diagram of the box (as a high point alarm).

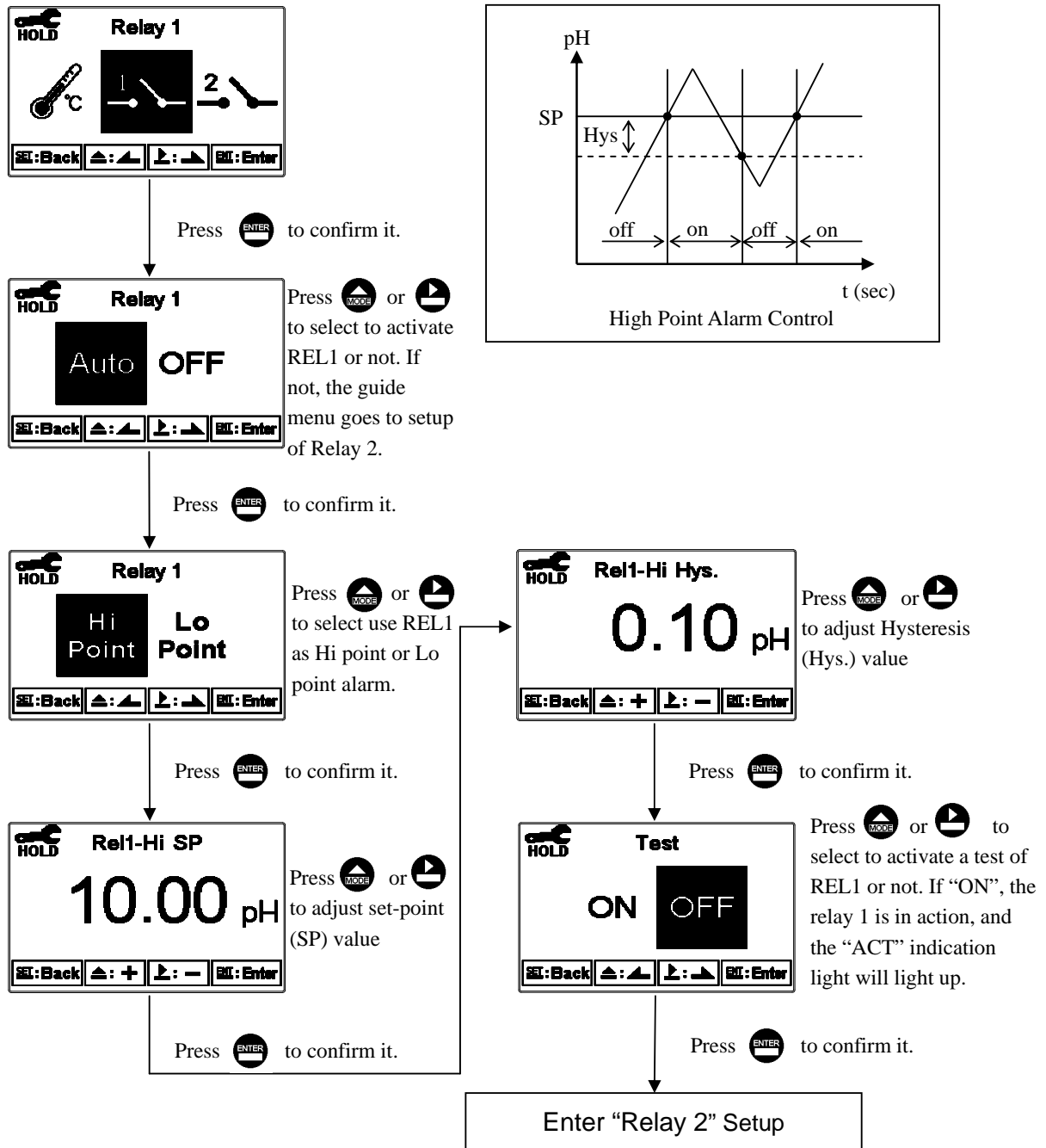

6.8 Relay 2

Enter setup of Relay 2. Select the item to turn on or turn of the relay 2 function. If you select to turn on the relay 2, then select for using relay 2 as “High set-point” alarm or “Low set-point” alarm. Set the value of set-point (SP) and Hysteresis (Hys.). The relationship between parameters can refer to an explanatory diagram of the box (as a low point alarm).

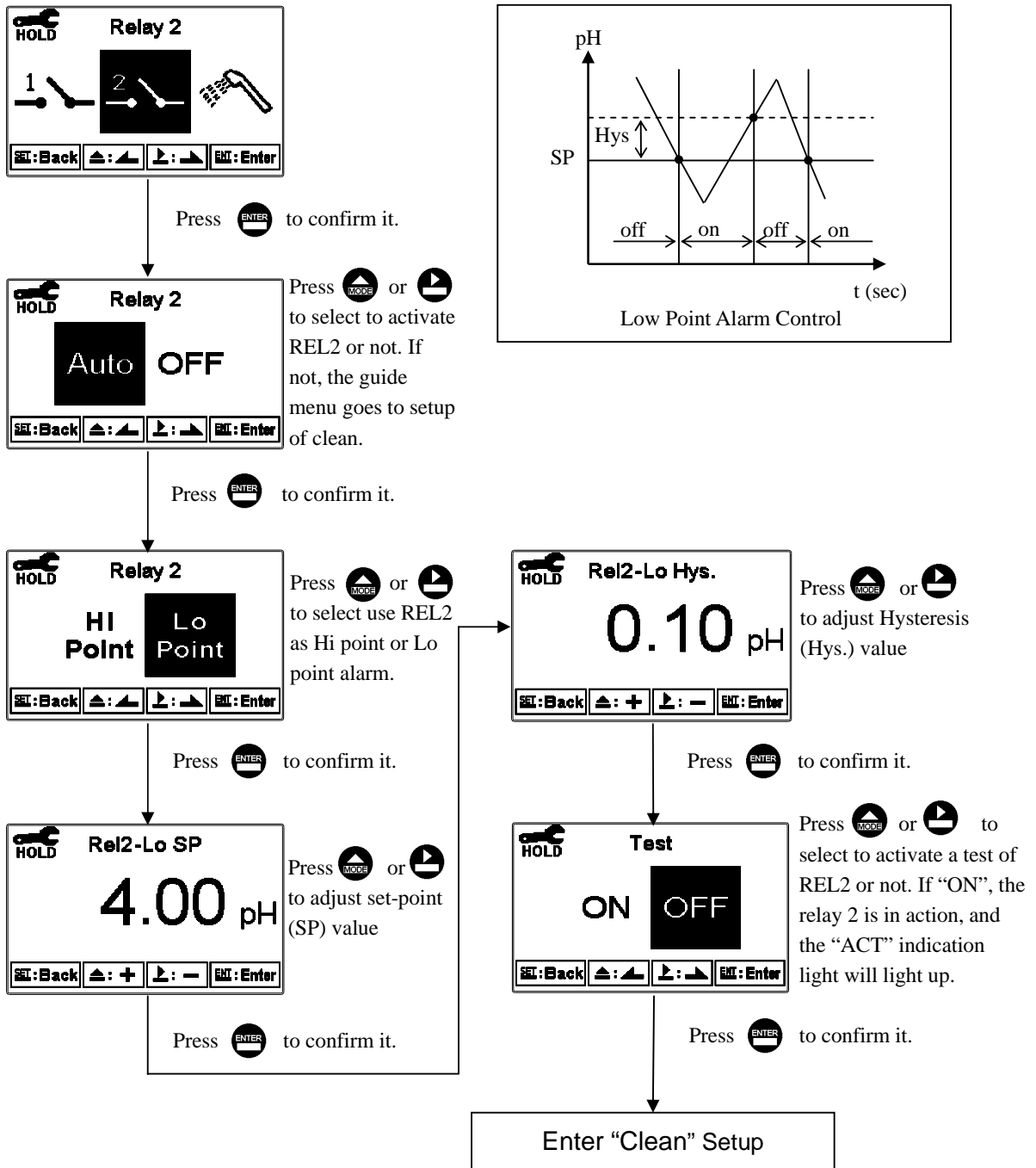

6.9 Clean

Enter setup of “Clean” function. Select the icon to turn on or turn off the clean function. If you select “Auto” turning on, then set the timer of the clean function including automatically turning on time and turning off time, and set the Hysteresis value(Hys.).

Note: When the clean function is turned on, if any value is set to 0, the instrument will automatically turn off this function. When the clean function is activated under measurement mode, there is a “Clean Running” message showing on top of the display. The measurement value will default to the last measured value before cleaning. If entering setting menu or calibration menu during clean status, the instrument will stop clean status automatically.

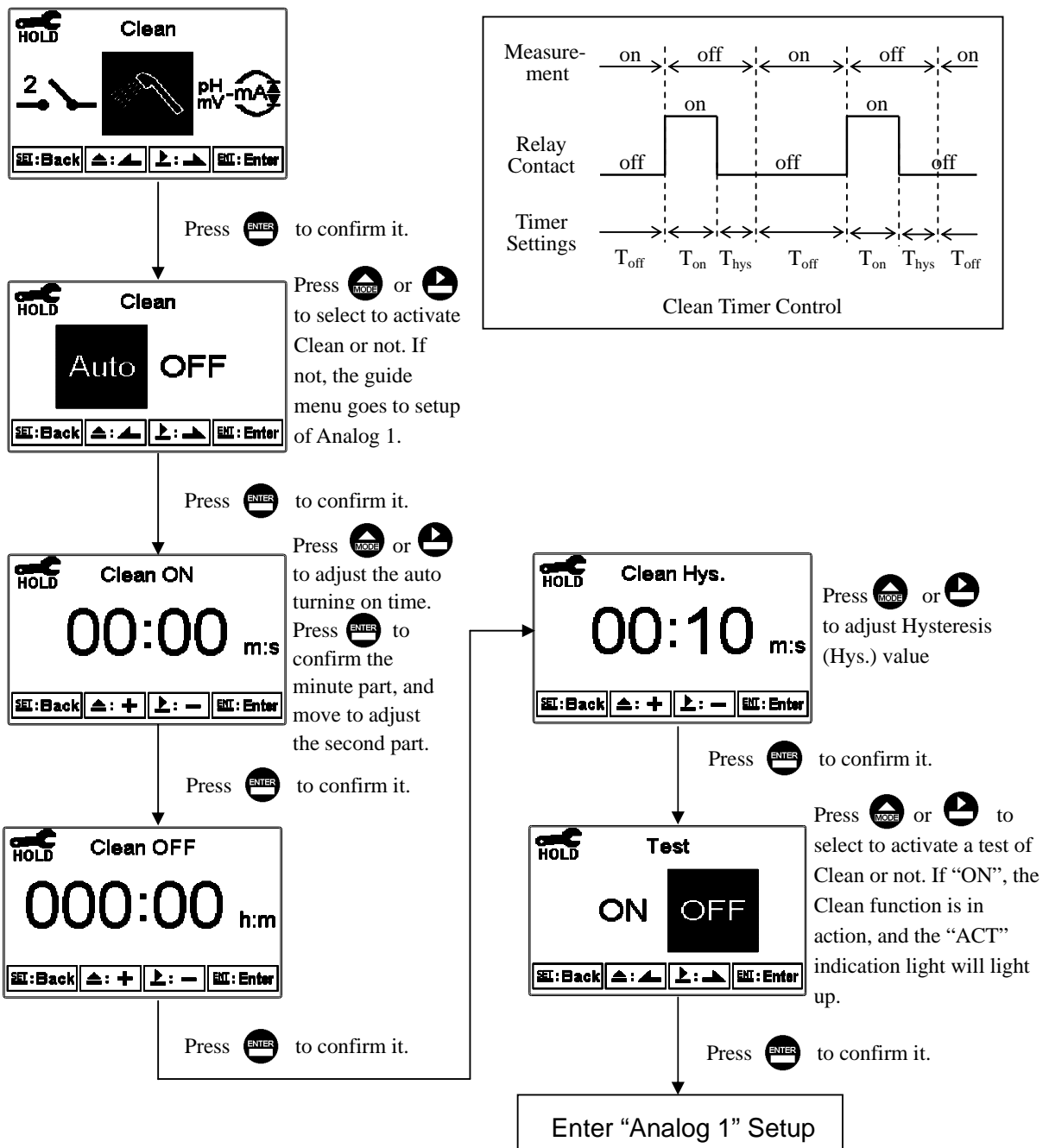

6.10 Analog output 1 (pH/ORP)

Enter setup of Analog 1. Select 0~20mA or 4~20mA current output. Set the related value to the range of pH/ORP measurement. If the range of the pH/ORP measurement is to be set smaller, the resolution of current output is higher. When the measured value exceeds the higher range limit, the current will remain approximately 22mA output. When the measured value exceeds the lower range limit, under 0~20mA mode the current output will remain 0mA output; while under 4~20mA mode the current output will remain approximately 2mA output. The exceptional output value can be used as a basis for failure determination. Under HOLD(measurement) status, the current output maintain the last output value before HOLD status. However, to ensure the current setting of an external recorder or of a PLC controller, the current output will be 0/4mA or 20mA under the analog output setup menu.

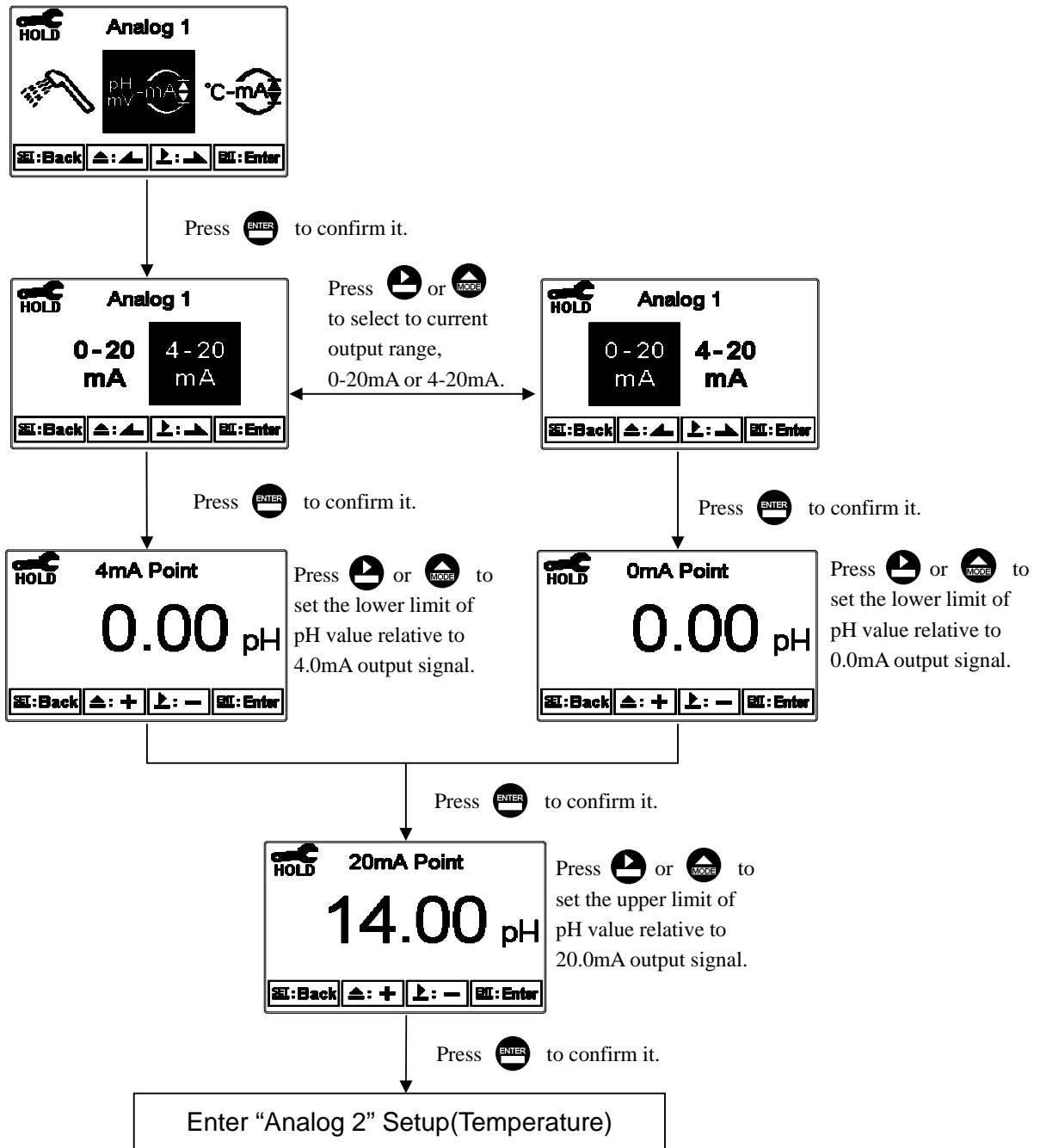

6.11 Analog output 2 (Temperature)

Enter setup of Analog 2. Select 0~20mA or 4~20mA current output. Set the related value to the range of temperature measurement. If the range of the temperature measurement is to be set smaller, the resolution of current output is higher. When the measured value exceeds the higher range limit, the current will remain approximately 22mA output. When the measured value exceeds the lower range limit, under 0~20mA mode the current output will remain 0mA output; while under 4~20mA mode the current output will remain approximately 2mA output. The exceptional output value can be used as a basis for failure determination. Under HOLD(measurement) status, the current output maintain the last output value before HOLD status. However, in order for convenience of insuring the current setting of an external recorder or of a PLC controller, the current output will be 0/4mA or 20mA under the analog output setup menu.

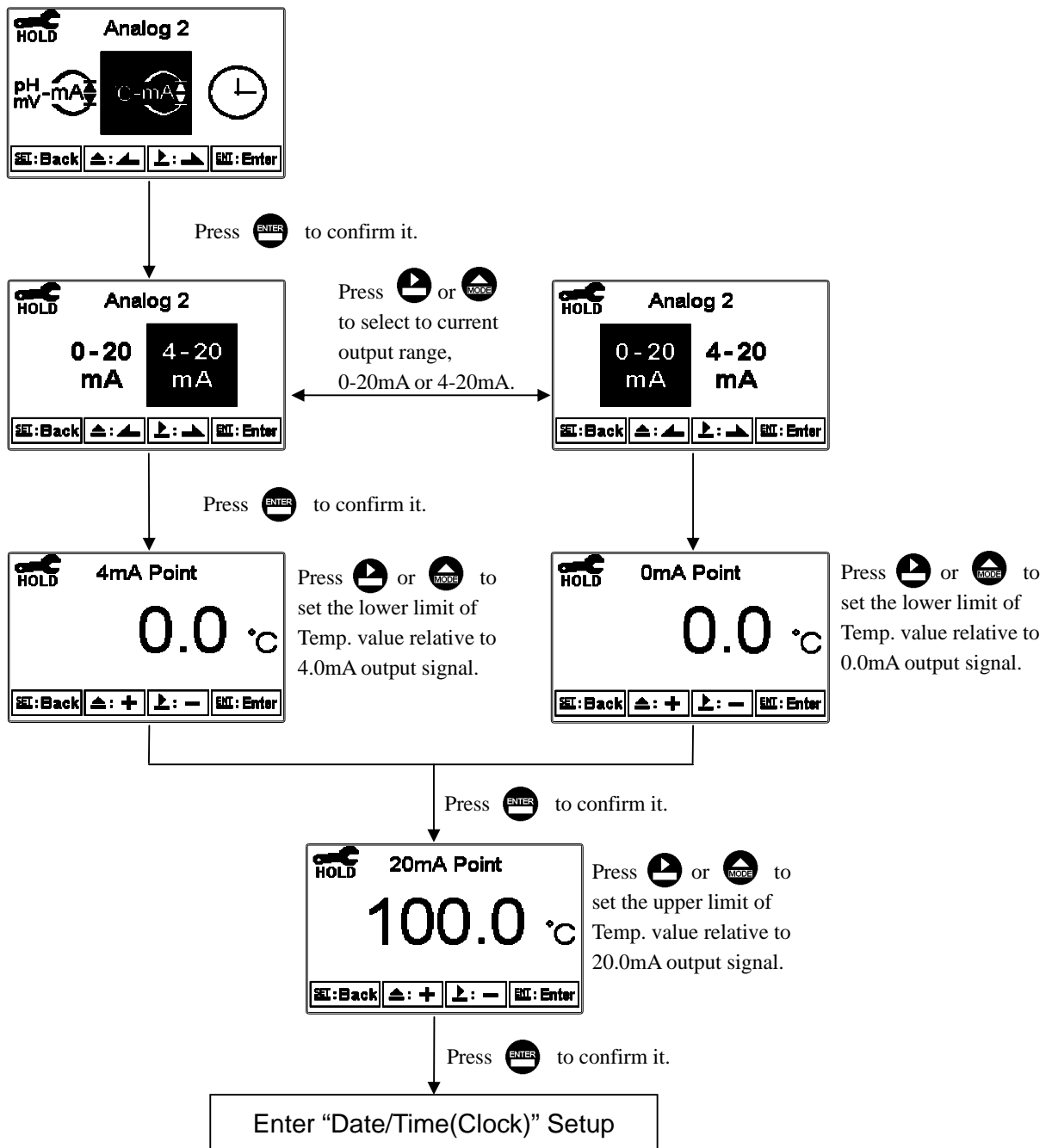

6.12 Date/Time(Clock)

Enter setup of Date/Time(Clock). Set the “Year”, “Month”, “Date”, “Hour”, and “Minute” time. If you select to turn off the clock function, the clock will not display in measurement mode. The calibration time of calibration record will also show ”OFF” at the calibration overview display.

Note: The clock needs to be reset in the event of a power failure.

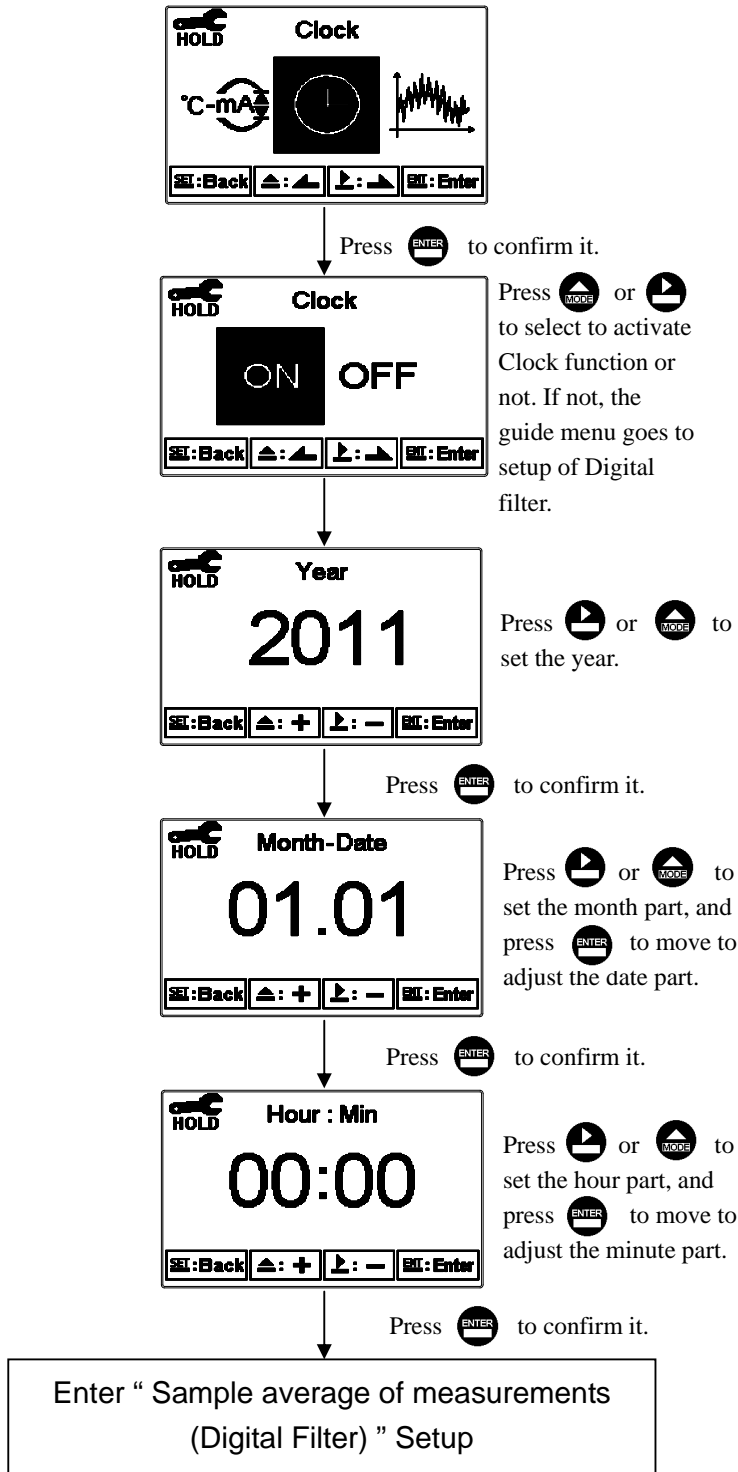

6.13 Sample average of measurements (Digital Filter)

Enter the setup of Digital filter. You may select the number of sample to be averaged each time to become a reading which is gradually counted in order to increase the stability of measurement.

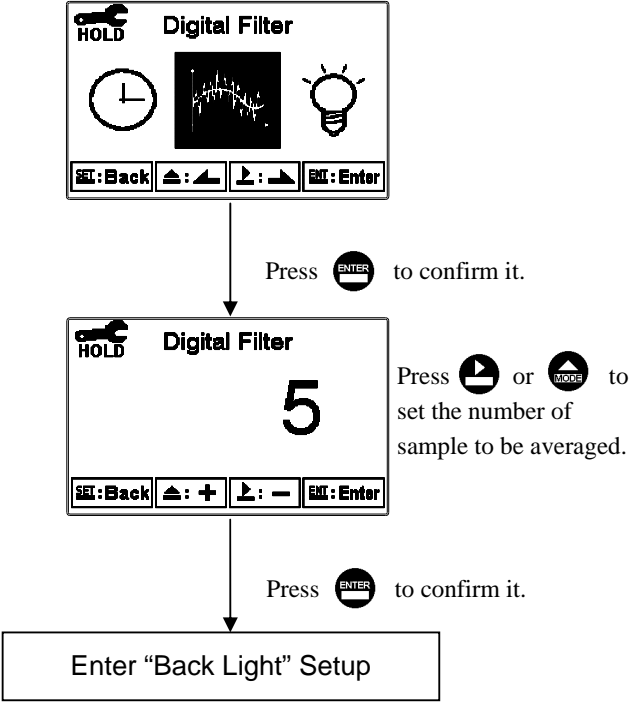

6.14 Backlight settings

Enter setup of backlight display. Set the brightness of display(-2~2, dark~bright) and sensitivity of the sensitization sensor(-2~2, insensitive~sensitive). When a key is pressed, the touch-on backlight function will be activated. Regardless of the type of backlight mode, the touch-on function will activate the backlight. If there is no keystroke for 5 seconds, the display will return to the original backlight setting status.

ON setting: The backlight is always on.

OFF setting: The backlight is off. When there is a keystroke, it enters to the touch-on status.

Auto setting: According to the ambient light, activate or deactivate the backlight. When there is a keystroke, it enters to the touch-on status.

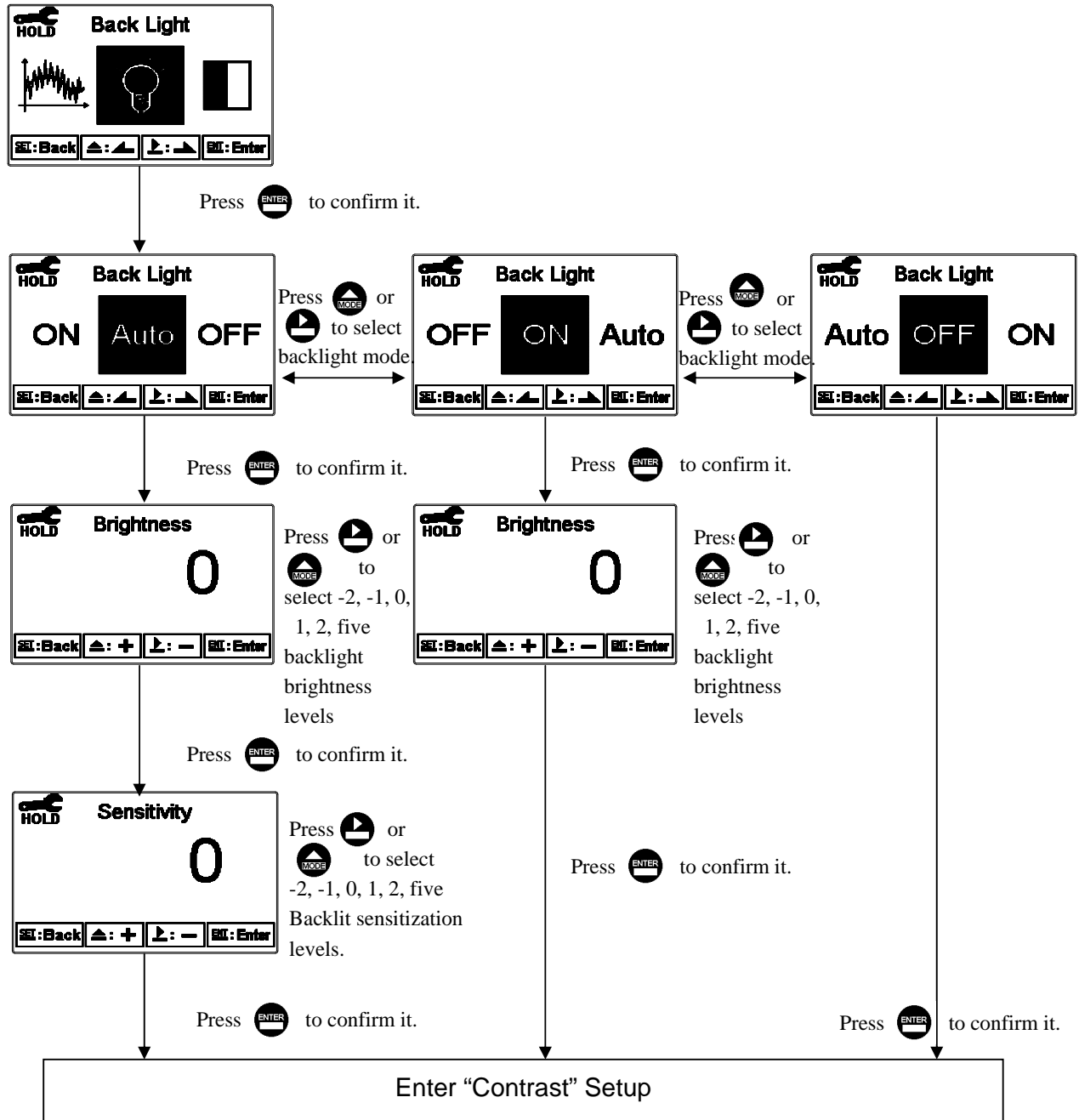

6.15 Contrast settings

Enter setup of display contrast. Set the contrast of display according to (-2, -1, 0, 1, 2, light to dark)

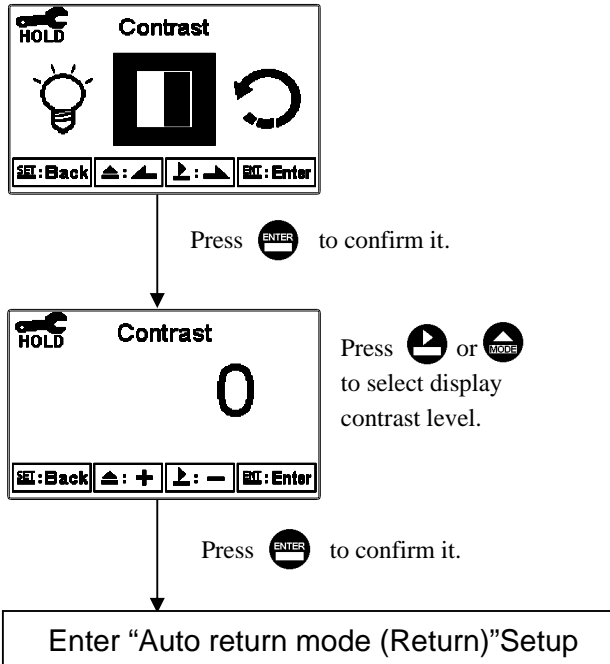

6.16 Return

Enter setup of auto return mode (Return) to set the function that the instrument automatically exit the setup menu after a period of time without pressing any key. The “Manual Exit” means that it needs to exit setup menu manually, while “Auto” means that the display will automatically exit the setup menu and return to measurement mode after a period of time without pressing any key.

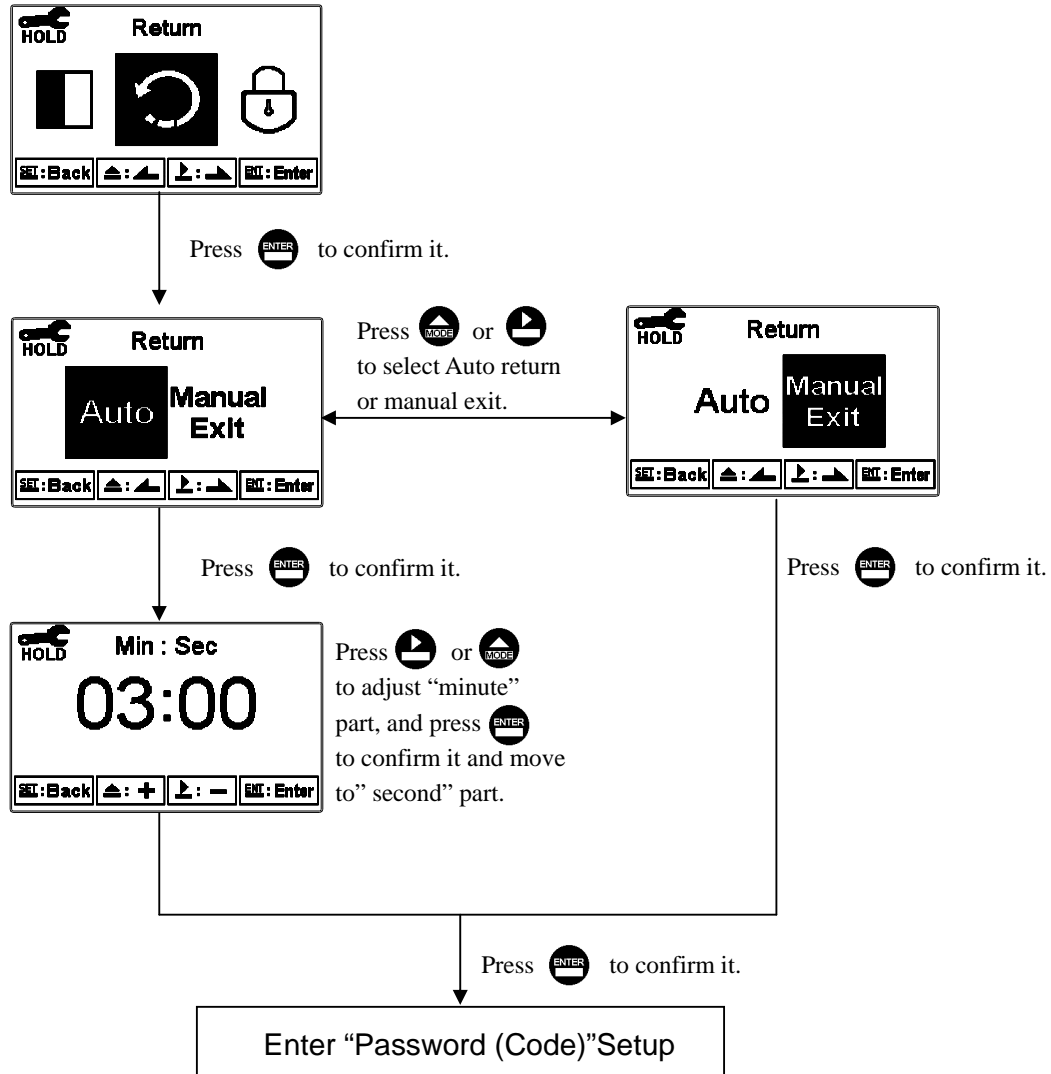

7. Calibration

Block diagram of Calibration

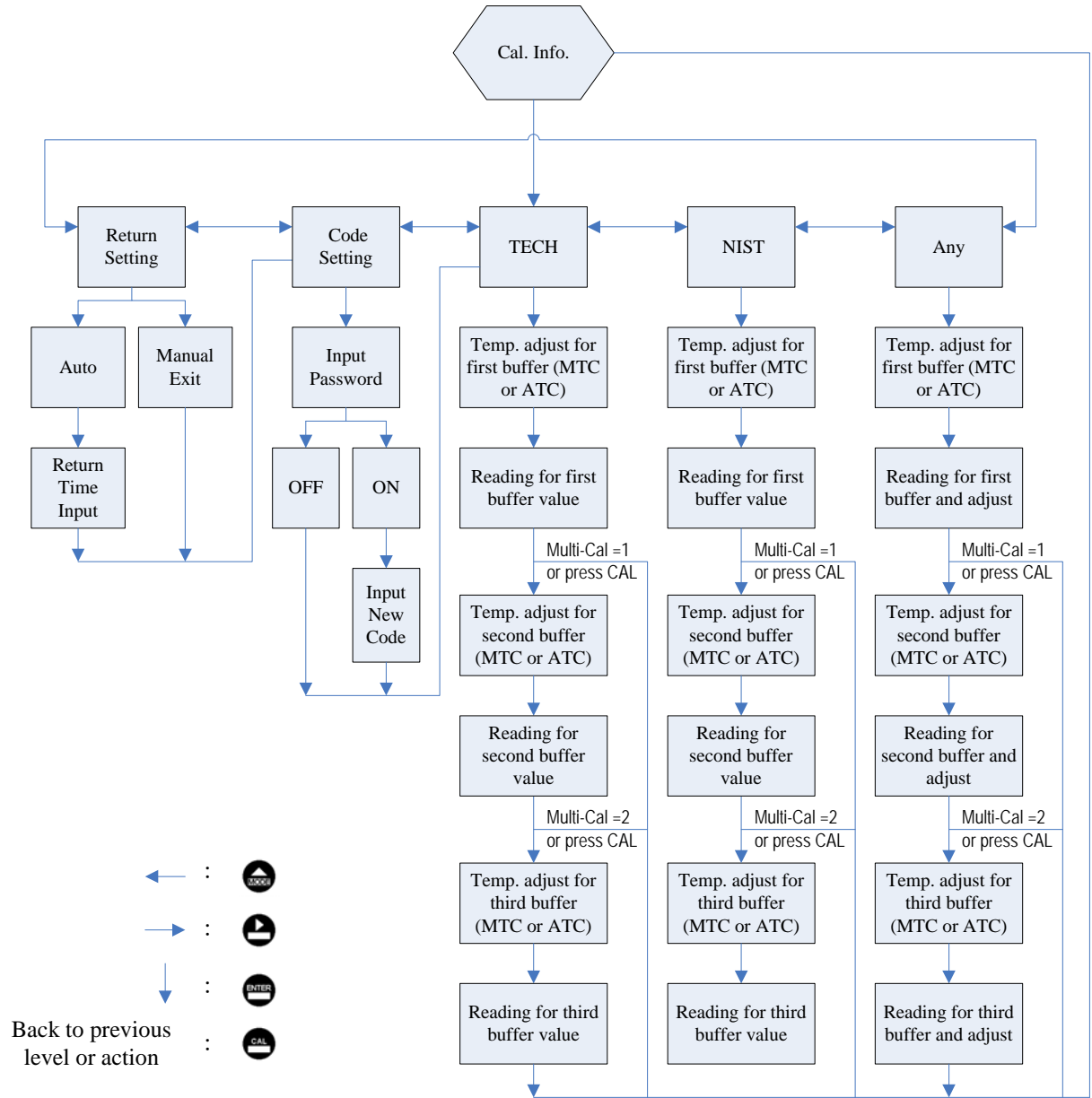

7.1 Enter calibration setup menu

In the measurement mode, pressing the two keys **CAL** and **MODE** simultaneously allows you enter the Calibration Information. If you do not need to re-calibrate the measurement system, press **CAL** to return to measurement mode. If you need to re-calibrate the system, press **ENTER** to enter to the calibration setup menu. (If the calibration time shows “OFF”, it represents that the clock function has been turned off.)

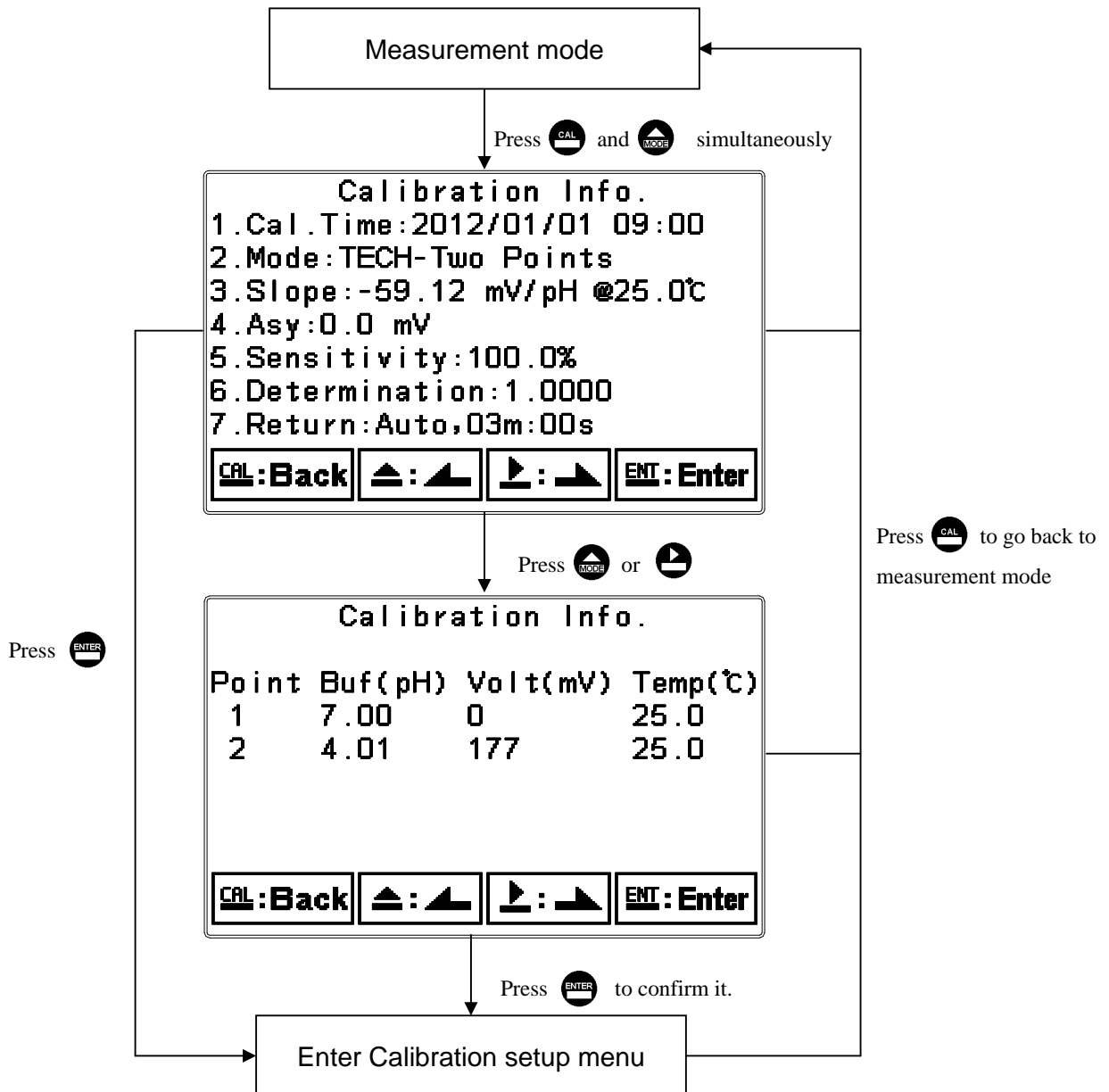

7.2 Security password of calibration (Code)

Select the Code (password) icon after entering calibration setup mode. Select to activate code function or not. **The default Calibration setting code is “1100”.**

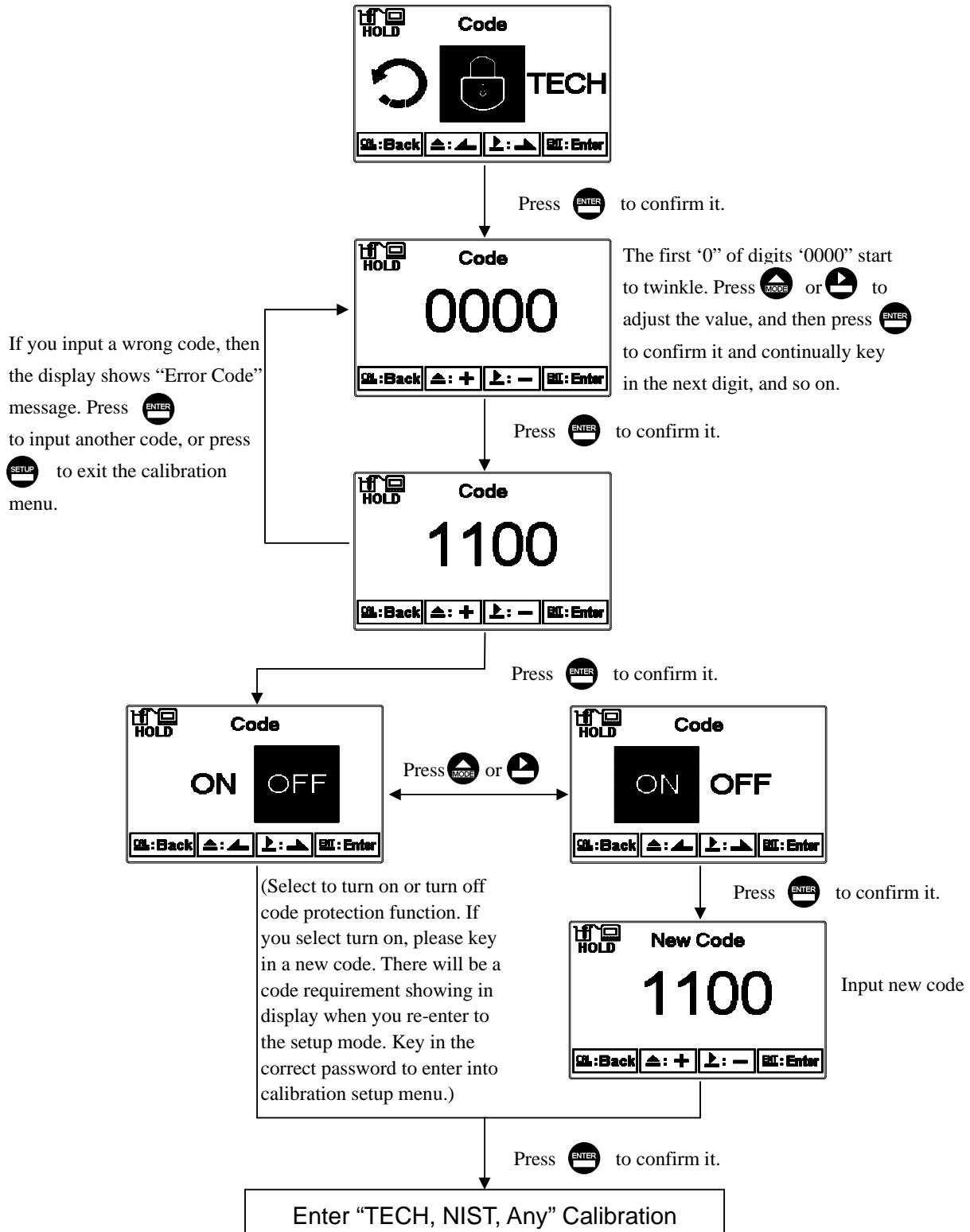

7.3 pH Calibration

The instrument provides multi-point standard buffer solution calibration. You may decide how many points to calibrate the measurement system (up to 3-point). The principle is according to “Method of Least Squares”. Apply linear regression to calibration the electrode’s slope and zero point (Any, Offset or Zero point).

When calibrating a electrode, you may calibrate 1 to 3 point in any sequence to provide linear regression for mV and pH multi-calibration of a electrode, and to show the electrode’s slope and zero point (Any, offset or Zero point) at 25°C. The electrode’s slope rate which is actual slope divided by theoretical slope and the sensitivity shows in percentage in the display. In addition, the display shows the linear regression determination coefficient, R², of the electrode and buffer solution to provide you an estimation of an electrode’s regression suitability. According to different combination of standard buffers, the TECH, NIST, Any buffer solution calibration modes are provided.

7.3.1 TECH mode

The electrode is automatically calibrated according to pH value and temperature of TECH standard buffers (pH4.01, pH7.00, pH10.00). The range of zero point and slope of the electrode is also determined. If one of them is over the range, the display shows error message of zero point and slope failure. (See appendix Table 1, pH/temperature table of TECH standard buffers)

7.3.2 NIST mode

The electrode is automatically calibrated according to pH value and temperature of NIST standard buffers (pH1.68, pH4.01, pH6.86, pH9.18, pH 12.45). The range of zero point and slope of the electrode is also determined. If one of them is over the range, the display shows error message of zero point and slope failure. (See appendix Table 2, pH/temperature table of NIST standard buffers)

7.3.3 Any mode

The electrode measures mV value of different standard solutions. According to theoretic slope and the temperature of standard solutions, the display shows an approximate pH value. Then, you can calibrate the electrode by freely adjusting the pH value to those of the standard solutions. There is not a zero point range failure determination by the instrument but only the slope range determination. If the slope is over the range, the display shows error message of slope failure.

7.3.4 Definition of calibration parameter

You can calibrate the electrode by one point or up to three points of standard solutions in any sequence. As different calibration point method is applied, the definition of the zero point and slope will be different.

Calibration point	Determination	The showed calibration value
One point calibration	Asy	Zero point (Asy, offset or Zero point)= Asy 1.If not calibrated, Slope = Theoretical slope 2.If calibrated, Slope = Slope of last calibration
Two or three point calibration	Asy Slope	Zero point (Asy, offset or Zero point)= Asy Slope = Slope* Note: To obtain a new zero point(Asy) and Slope by applying linear regression.

7.3.5 TECH, NIST buffer Calibration

The procedure below is two-point calibration of TECH buffer. (The procedure is same as NIST buffer mode.) First, enter the setup of Multi-points calibration and set the number of calibration point to 2. (See chapter 6.5 Multi-Cal) Then, go to Calibration menu and select TECH mode. Follow the procedure diagram below. For three-point calibration, you will need to set 3 points in the Multi-Cal setting in advance. The calibration procedure will then be the same.

Clean the electrode with distilled water and then put it into the second buffer. If under MTC temperature mode, press or to adjust temperature value. Or press to decide to simply make a single point calibration.

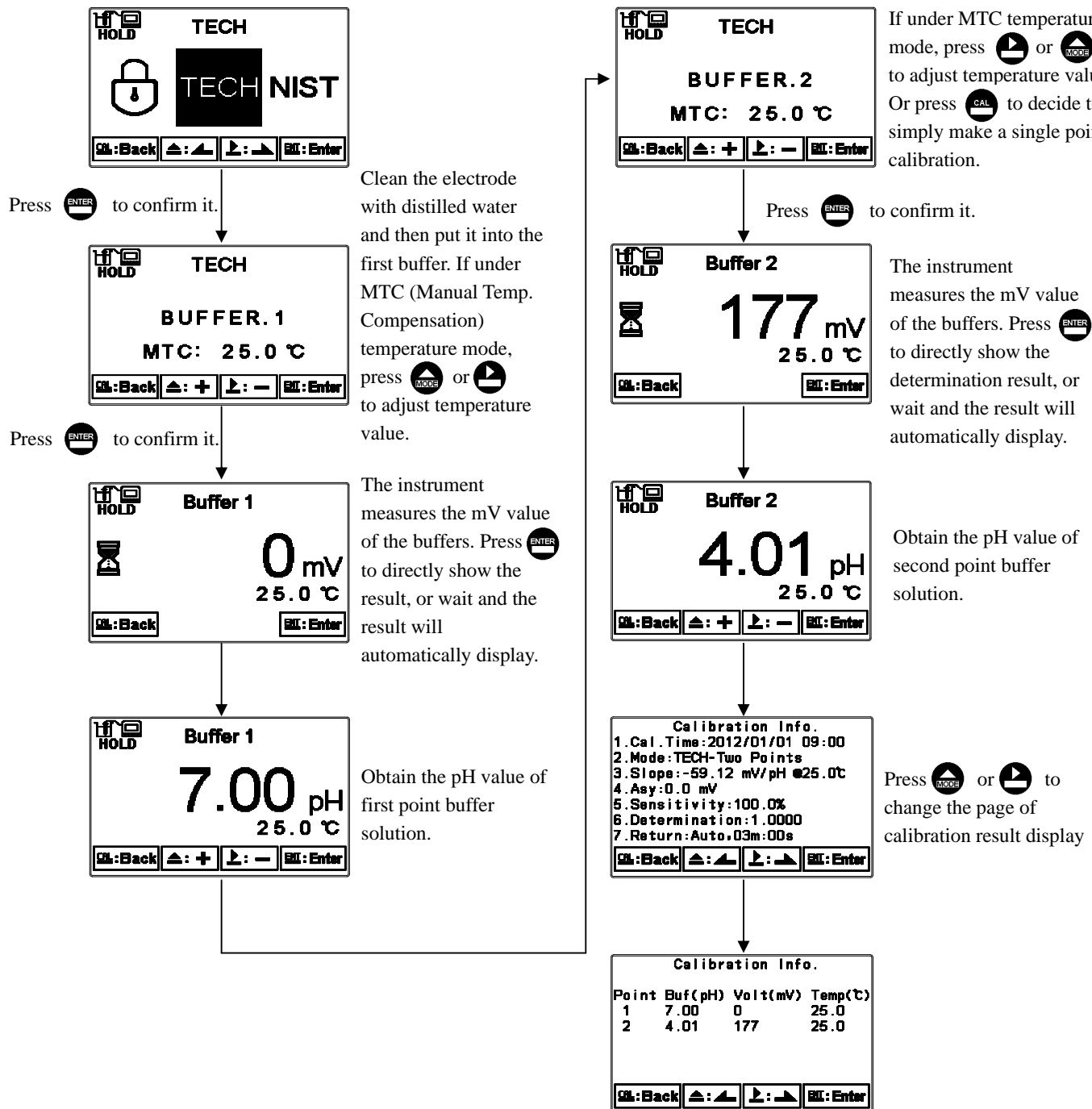

7.3.6 Any Calibration

The procedure below is two-point calibration of Any mode. First, enter the setup of Multi-points calibration and set the number of calibration point for 2. (See chapter 6.5 Multi-Cal) Then, go to Calibration menu and select “Any” mode. Follow the procedure diagram below. For three-point calibration, you will need to set 3 points in the Multi-Cal setting in advance. The calibration procedure will then be the same.

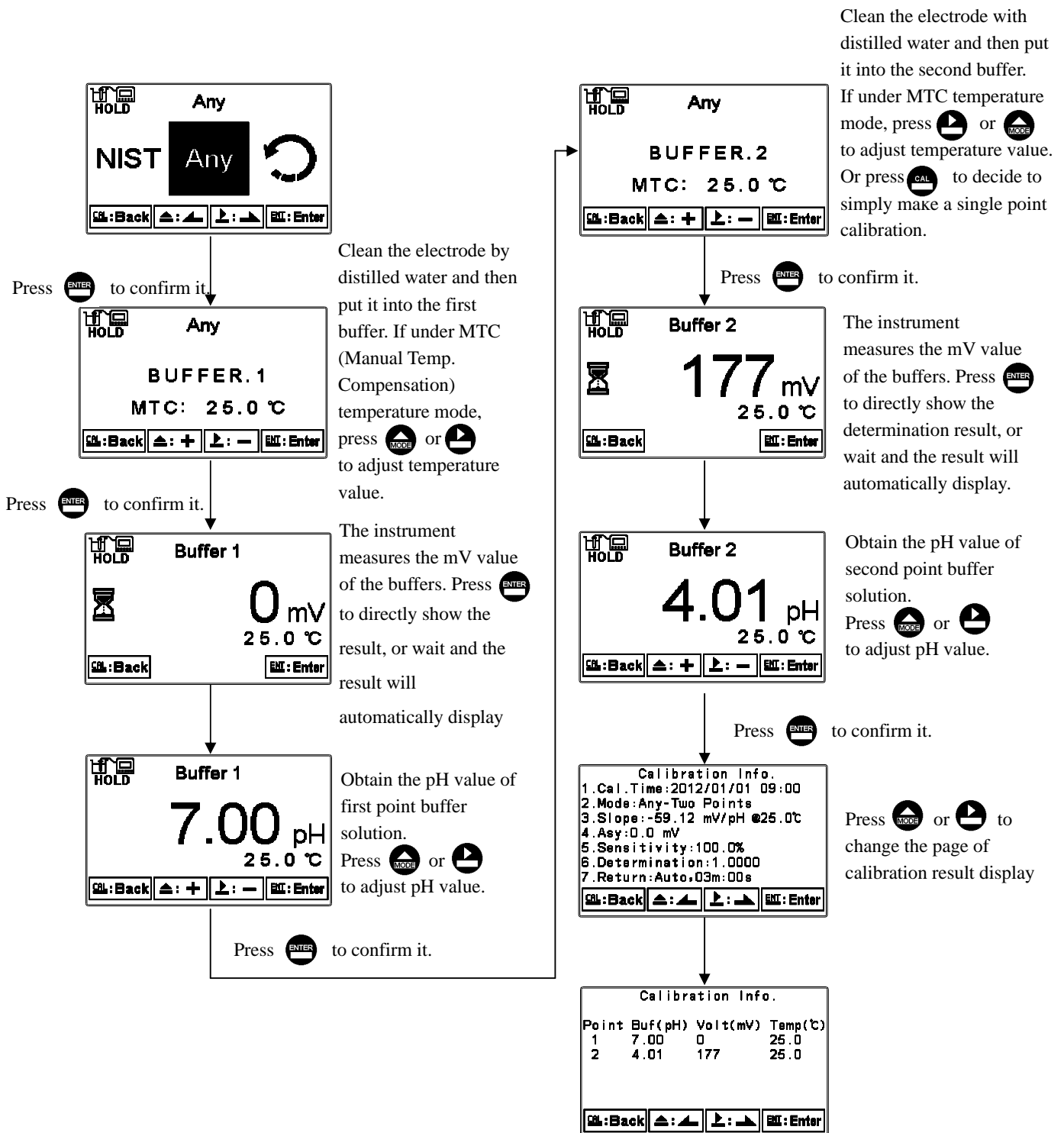

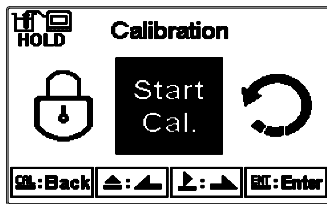

7.4 ORP Calibration

Under ORP measurement mode, enter calibration setup menu. Select Calibration icon, and adjust mV value. The adjustable range is from -300mV to 300mV.

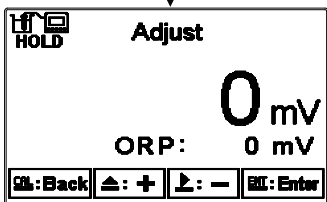

Press  to confirm it.



Put the ORP electrode into ORP standard solution. Press  or  to adjust the main display value until it is equal to the desired mV value.

Press  to confirm it.



7.5 Return

Enter setup of auto return mode (Return) to set the function that the instrument automatically exit the setup menu after a period of time without pressing any key. The “Manual Exit” means that it needs to exit calibration setup menu manually, while “Auto” means that the display automatically exit the calibration setup menu and back to measurement mode after a period of time without pressing any key.

Note: The return function of setup menu and calibration setup menu are independent settings.

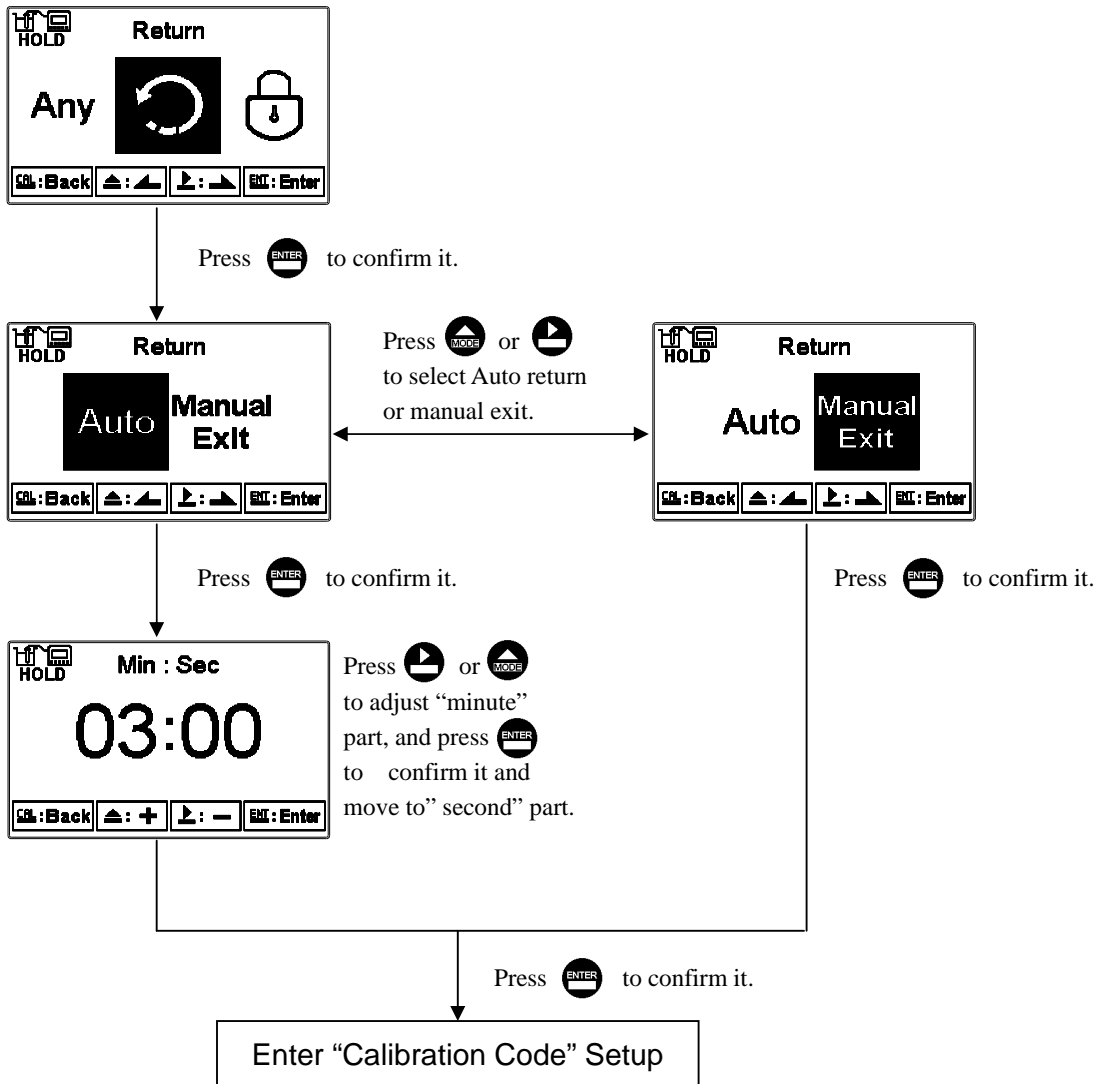

8. Error messages (Error code)

Messages	Reason	Dispositions
Error1	Asy (Zero-point) exceeds upper/lower limitation	<ol style="list-style-type: none"> 1. Please use new buffers. 2. Clean the electrode or change to a new electrode, and make another calibration.
Error2	Slope exceeds upper/lower limitation	<ol style="list-style-type: none"> 1. Please use new buffers. 2. Clean the electrode or change to a new electrode, and make another calibration.
Error3	The readout is unstable	<ol style="list-style-type: none"> 1. Check whether there is bubble or air in the glass end of the electrode 2. Clean the electrode or change to a new electrode, and make another calibration.
Error4	<ol style="list-style-type: none"> 1. The temperature is over the range 0~50°C during calibration. 2. Buffer cannot be recognized 	<ol style="list-style-type: none"> 1. Please adjust the standard solution to the proper temperature range. 2. Please check whether there is bubble or air in the glass end of the electrode, or maintain the electrode or change a new electrode, and make another calibration.
Error5	Wrong password ERROR CODE	Re-enter a password
Error9	Serious error that does not permit any further measuring	Please contact Sensorex Technical Support.

9. Maintenance

Generally speaking, under normal operation, the transmitter needs no maintenance except regular cleaning and calibration of the electrode to ensure accurate and stable measurement and system operation.

The cleaning cycle for the electrode depends on the pollution degree of the measurement sample. Normally, it is recommended to make weekly cleaning. Consult your electrode instruction manual for detailed cleaning and care directions.

Appendix

Table 1 TECH Buffers

TECH buffers			
TEMP°C	Buffer 4.01	Buffer 7.00	Buffer 10.00
5	3.999	7.087	10.241
10	3.998	7.053	10.155
15	3.999	7.031	10.116
20	4.002	7.011	10.047
25	4.006	6.996	9.998
30	4.011	6.985	9.952
35	4.018	6.976	9.925
40	4.031	6.971	9.874
45	4.047	6.969	9.843
50	4.055	6.969	9.810

Table 2 NIST Standard buffers

NIST standard buffers(DIN 19266)					
TEMP°C	Buffer 1.68	Buffer 4.01	Buffer 6.86	Buffer 9.18	Buffer 12.45
5	1.668	4.004	6.951	9.395	13.207
10	1.670	4.000	6.923	9.332	13.003
15	1.672	3.999	6.900	9.276	12.810
20	1.675	4.001	6.881	9.225	12.627
25	1.679	4.006	6.865	9.180	12.454
30	1.683	4.012	6.853	9.139	12.289
35	1.688	4.021	6.844	9.102	12.133
40	1.694	4.031	6.838	9.068	11.984
45	1.700	4.043	6.834	9.038	11.410
50	1.707	4.057	6.833	9.011	11.705

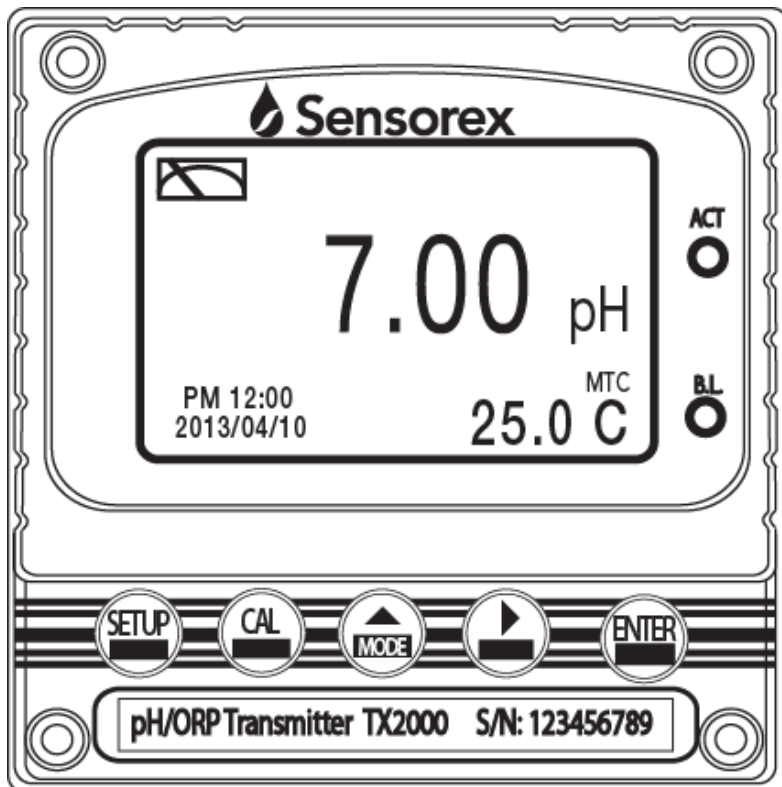

 **Sensorex**[®]
11751 Markon Dr.
Garden Grove, CA 92841 USA
Tel: 714-895-4344
Fax: 714-894-4839
E-mail: info@sensorex.com
www.sensorex.com