

Instruction **Manual**

Liquitron™ DR5000 Series ORP (Redox) Controller

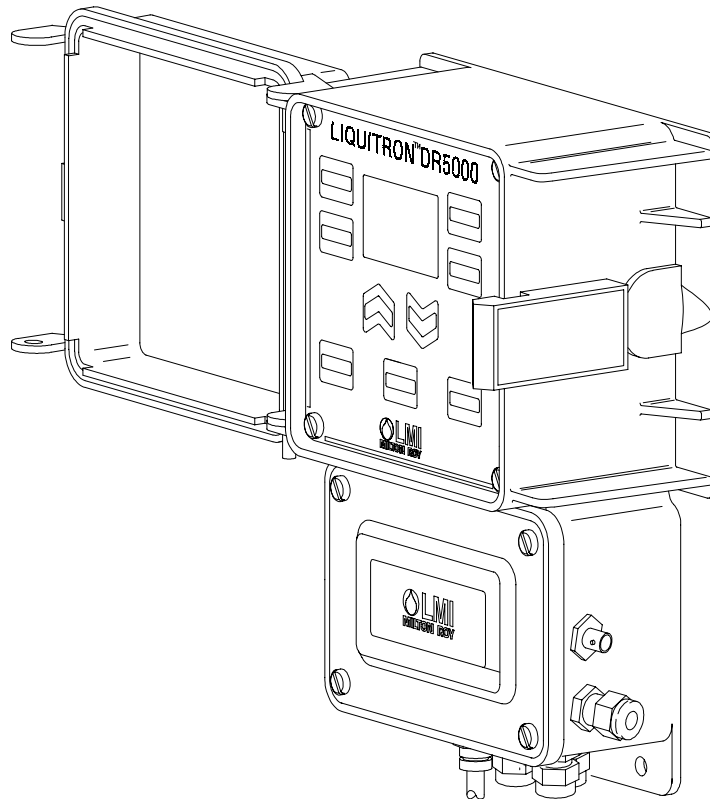

For file reference, please record the following data:

Model No: _____

Serial No: _____

Installation Date: _____

Installation Location: _____

When ordering replacement parts for your LMI Controller or accessory, please include the complete Model Number and Serial Number of your unit.



8 Post Office Square
Acton, MA 01720 USA
TEL: (978) 263-9800
FAX: (978) 264-9172
<http://www.lmipumps.com>



Contents

1.0	Introduction	3
2.0	Unpacking	3
3.0	Installation	4
3.1	Mounting the Electronic Enclosure	4
3.2	Electrical Installation	6
3.2.1	Terminal Board Signal Description	7
3.2.2	Field Wiring Instructions (Optional 4-20 mA Output)	8
3.3	ORP Adjustment Pump(s)	9
3.4	Keypad and Display	9
4.0	Operation	11
4.1	Proportional Mode	12
4.2	On/Off Mode	13
4.3	Alarms	14
4.4	Calibration (Viewing Last Calibration Data)	15
4.5	Performing a New Calibration	16
4.6	Pump Timers and Solenoid Valve Control Timers	17
4.7	Advanced Menu List	20
5.0	Maintenance	20
5.1	ORP Electrode and Cable	20
6.0	Troubleshooting	21
6.1	Error Messages	21
7.0	DR5000 Specifications	22
8.0	Parts List	24
9.0	Exploded View	25
10.0	Program Log	26
11.0	Statement of Limited Warranty	27

1.0 Introduction

The Liquitron™ DR5000 Series ORP (Oxidation Reduction Potential) Controllers are designed for a variety of industrial ORP applications including metal finishing, water treatment, printed circuit board manufacturing and waste treatment.

The DR5000 is a microprocessor-based ORP controller with a backlit customized display and tactile keypad for ease of programming. The DR5000 allows independent programming of control methods (**On/Off** or **Proportional**) for reducing agent (Pump A) or oxidizing agent (Pump B) dosage. Independent high and low ORP alarms may be set with activation of the ‘Alarm relays.’ A third relay output is available for activating a solenoid valve or other devices.

The controller is compatible with any ORP electrode that generates a mV signal. Two point or single point ORP calibrations may be performed. Timer functions for pump ‘Run’ time and solenoid ‘Delay’ times can be programmed to operate a solenoid pump valve. An ‘Advanced Menu’ allows selection of special features such as a ‘Point 3’ (inflection point) for the control profiles of the reducing agent or oxidizing agent pumps for finer control. The DR5000 features continuous non-volatile memory backup, voltage selection, pre-amplifier outputs, flow and level switch inputs as standard, 4-20 mA recorder output is optional.

2.0 Unpacking

Your carton will contain the items shown in Figure 1. Please notify the carrier immediately if there are any signs of damage to the Controller or its parts. Contact your LMI Distributor if any of the parts are missing.

There is a number label on the inside cover of the unit; for easy reference, you should note the model and serial numbers on the front cover of this instruction manual.

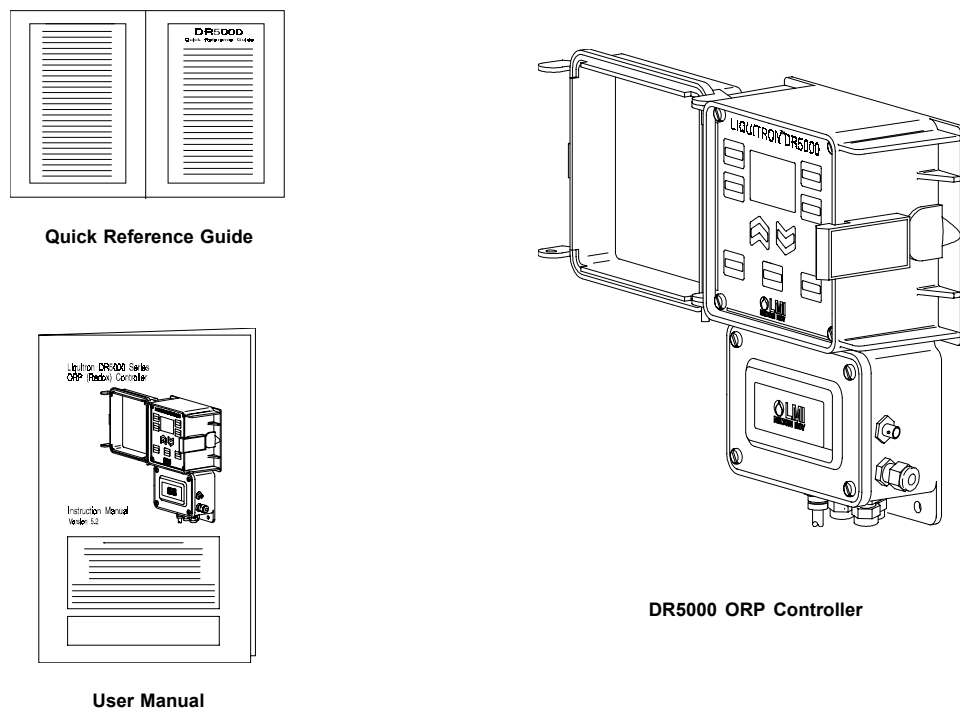

Figure 1: Unpacking Items

3.0 Installation

Pre-Installation

Cord & Voltage Code



Be sure that the unit has a plug and voltage code compatible with the power source that you intend to use.

Environment:

The housing is corrosion and spray resistant but should not be subjected to excessive spray or ambient temperature over 122° F (50° C). Never immerse the unit.

Installation

The DR 5000 Controller should be mounted on a solid, stable surface. ORP adjustment pumps should be installed following the manufacturer's recommendations. For installations requiring longer cables, consult your distributor. The electrode installation will vary, depending on the process used. In general, the temperature electrode and ORP electrode should be mounted together, and placed far enough downstream from the source of ORP adjusting solution that sufficient mixing may occur, but close enough to eliminate hydraulic lag time of response. Refer to the typical installation diagrams (Figures 3A and 3B) on the following pages.

3.1 Mounting the Electronic Enclosure

The DR5000 Control module is supplied with integral wall-mounting flanges. It should be hung with the display at eye level, on a vibration-free structure, in a location where liquids will not be splashed on it. All four (4) top mounting holes should be used for structural stability. The control module requires the following clearances:

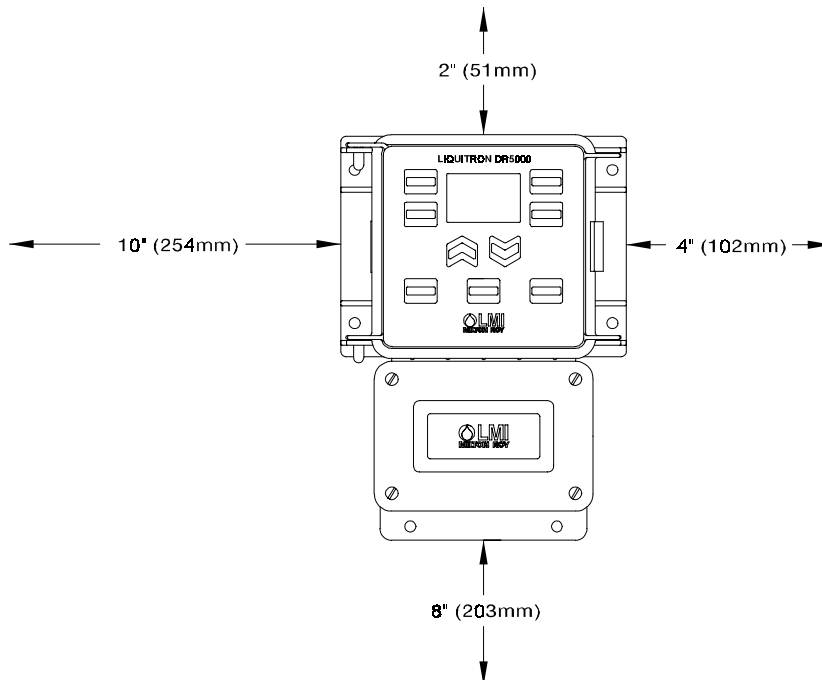

Figure 2: Minimum Clearances

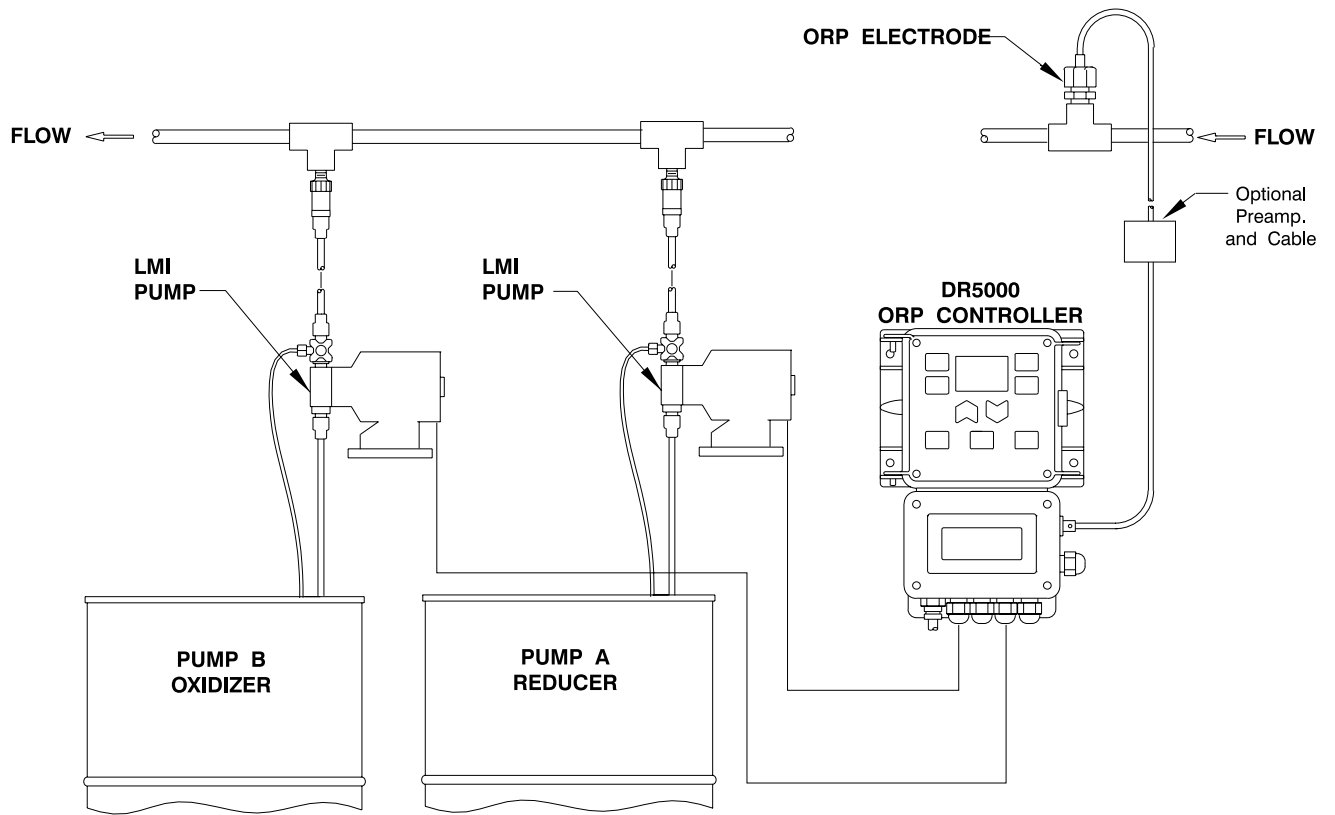

Figure 3A: Typical In-Line Installation

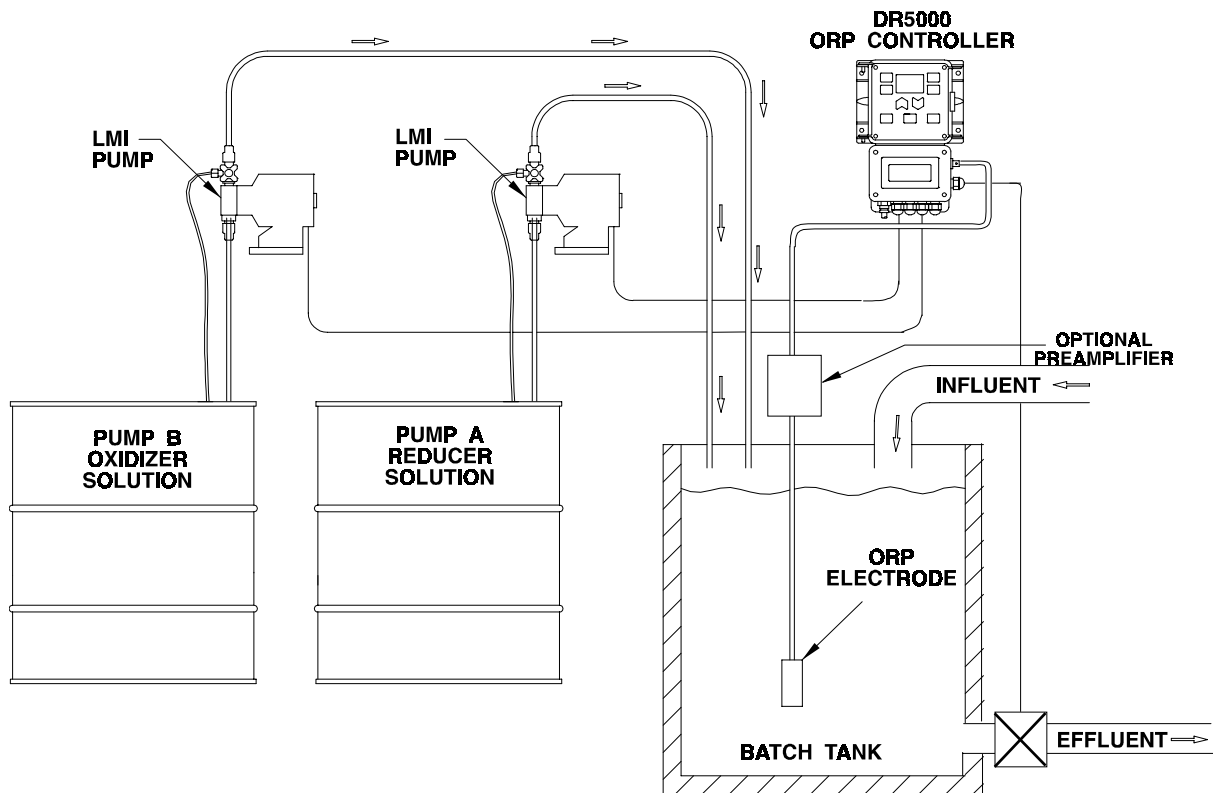

Figure 3B: Typical Batch Installation

3.2 Electrical Installation

ELECTRICAL CONNECTIONS



To reduce the risk of electrical shock, the control or metering pump must be plugged into a grounded outlet with ratings conforming to the data on the control panel. It must be connected to a good ground. **DO NOT USE ADAPTERS!** All wiring must conform to local electrical codes.

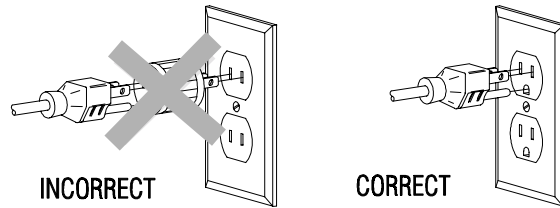

Electrical installation of the DR5000 Series ORP controllers consists of plugging the control module into a proper line outlet. Based on model number, the following voltages and receptacles are required:

DR5000-1A DR5000-1B 115 V, 60 Hz USA Cord	DR5000-3A DR5000-3B 230 V, 50 Hz DIN Cord	DR5000-6A DR5000-6B 230 V, 50 Hz AUS/NZ Cord	DR5000-01A DR5000-01B 115 V, 60 Hz No Cord
DR5000-2A DR5000-2B 230 V, 60 Hz USA Cord	DR5000-5A DR5000-5B 230 V, 50 Hz UK Cord	DR5000-7A DR5000-7B 230 V, 50 Hz SWISS Cord	DR5000-02A DR5000-02B 230 V, 50/60 Hz No Cord

Connect the ORP adjustment pump(s) to the terminal strip for **On/Off** mode control (connect to receptacles directly for 115 V models) or to cables for **Proportional Output** mode control. Connect the ORP electrode to the BNC connector on the right side of the control module. Take care not to twist or strain the wires. You may optionally connect an alarm, solenoid, flow switch and low level switch. You may also connect the mA connections (optional). The ± 5 V supply for electrode pre-amplification is also accessed on the terminal strip. There is a 500 W maximum resistance for 4-20 mA option when used.

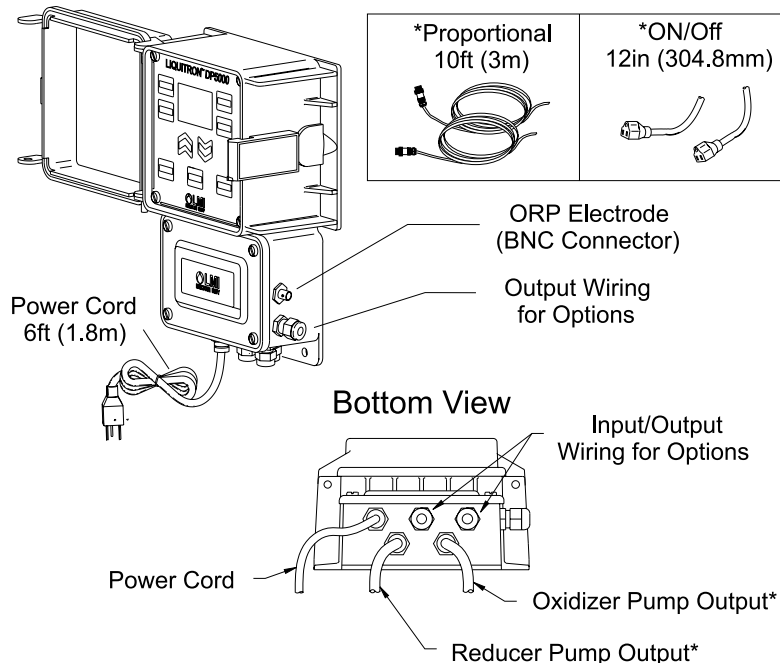
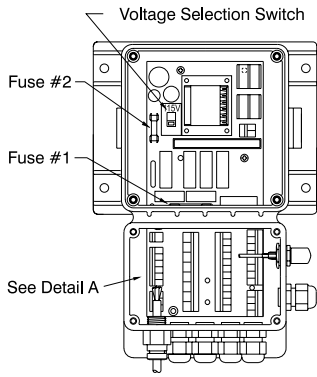

Figure 4: Electrode and Pump Connections



Detail A

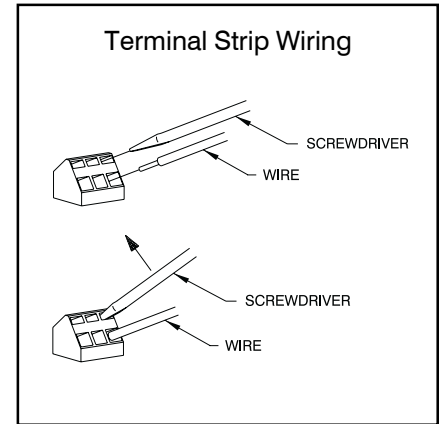
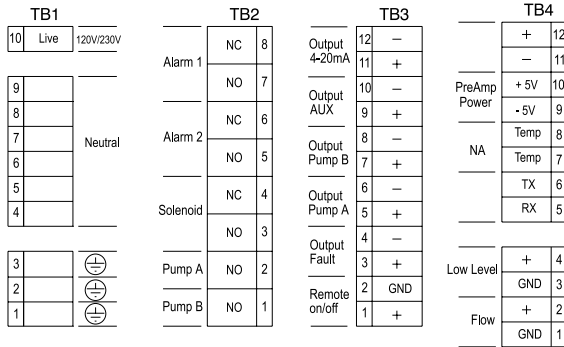

Figure 5: Terminal Strip

3.2.1 Terminal Board Signal Description

Terminal blocks are TB1-TB4 from left to right, and Pin 1 is at the bottom of each terminal block.

TB1 Terminal Strip

- TB1 Pin 1-Pin 3 Earth connection (one for input power connection)
- TB1 Pin 4-Pin 9 Neutral power connection (one for input power connection)
- TB1 Pin 10 AC Mains live input

TB2 Terminal Strip

- TB2 Pin 1 Form A contact closed when Pump B (oxidizer) is ON
- TB2 Pin 2 Form A contact closed when Pump A (reducer) is ON
- TB2 Pin 3-4 Form C contact activated, (if programmed) when ORP is within programmed limits (solenoid pump)
- TB2 Pin 5-6 Form C contact activated when Alarm Set Point 2 exceeded (powered output contacts)
- TB2 Pin 7-8 Form C contact activated when Alarm Set Point 1 exceeded (powered output contacts)

TB3 Terminal Strip

- TB3 Pin 1-2 Opto isolated input - low or short stops pumps Set Point (OFF on display)(Remote ON/OFF)
- TB3 Pin 3-4 Opto isolated output - low when alarm condition exists
- TB3 Pin 5-6 Opto isolated output - pulse train to drive Pump A
- TB3 Pin 7-8 Opto isolated output - pulse train to drive Pump B
- TB3 Pin 9-10 Spare, not programmed
- TB3 Pin 11-12 4-20 mA output proportional to ORP (programmable limits) (optional)

TB4 Terminal Strip

- TB4 Pin 1-2 Opto isolated input - flow switch input (add jumper if no flow switch is used)
- TB4 Pin 3-4 Opto isolated input - level switch input (add jumper if no level switch is used)
- TB4 Pin 5-6 Serial Communications (NA)
- TB4 Pin 7-8 Temperature input (NA)
- TB4 Pin 9-10 Power voltage source for preamp
- TB4 Pin 11-12 Spare, not programmed

3.2.2 Field Wiring Instructions

Typical US field installation would find a 6 ft (2 m) AC cord wired and two (2) 1 ft (30 cm) AC receptacles (**On/Off** mode) or two (2) 10 ft (3 m) pump drive cables (**Proportional** mode) installed. A BNC receptacle would be installed for the ORP probe.

Connect the two (2) pumps appropriately. Install the probe, run the cable back to the controller and attach to BNC receptacle. If the probe is farther than 25 ft (7.6 m) from the controller, a preamp may be desirable to reduce noise effects. If this is the case, use +5V/-5V from control box TB4 Pin 9-10 for your preamplifier. Current draw must not be greater than 10 mA.

If a flow meter and/or low-level tank switch is available, run wires to the controller entering through one of the spare cable ports. Remove the appropriate jumper(s) and attach the external wires. Polarity does not matter. Wire size #20-22 is adequate.

Alarm relays 1 and 2 are provided to signal an out of tolerance condition externally. These are Form C contacts, providing a common, a normally open, and a normally closed connection. These terminals provide power output.

A solenoid drive relay (Form C contacts, providing a common, a normally open and a normally closed connection) is provided that can be connected to drain a tank when the ORP is within programmed limits. A delay can be programmed after initially entering this programmed zone, to allow conditions to settle within the tank. The duration of solenoid **On** time is also separately programmable. Wire size #16-18 is recommended. These terminals provide output power (main voltage).

The optional 4-20 mA PCB provides a fully programmable 4-20 mA output based on the ORP readings. The optional PCB plugs into the back of the computer PC board, as shown in Figure 6.

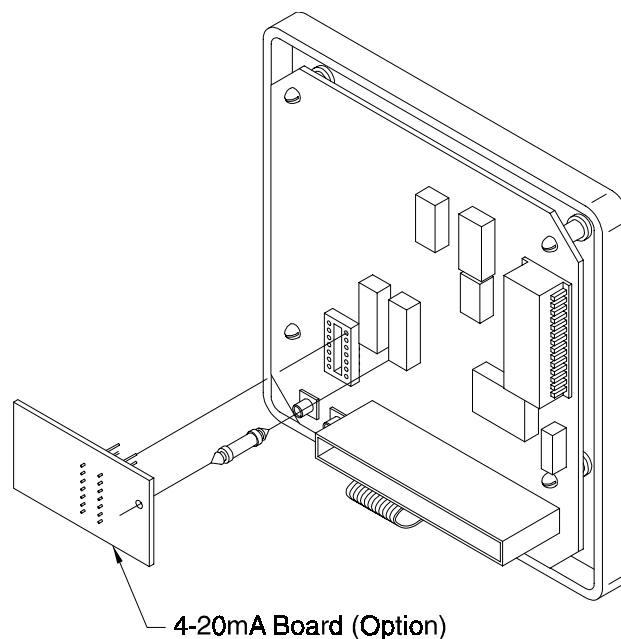

Figure 6: Circuit Board

3.3 ORP Adjustment Pump(s)

There are two (2) versions of the DR5000, one is the **On/Off Output** mode, and the second is **Proportional Output** mode.

In the **On/Off Output** mode, the DR5000 ORP Controller will operate any ORP adjustment pump(s) which operate on the same line voltage as the controller itself. Combined continuous controlled load must not exceed 6A @ 115V or 3A @ 230V. To ensure efficient control, the pumps should be capable of delivering at least 150% of the maximum pumping requirement. Install and calibrate the pumps according to the manufacturer's recommendations.

In the **Proportional Output** mode, the DR5000 ORP Controller will operate any LMI Series A9, A7, B9, B7, C9, C7, E7 or L7 pump, or any other pump which operates by providing direct proportional response to a modulated pulse input signal. The pumps must be set to the 'external' control mode. To ensure efficient control, the pumps should be capable of delivering at least 150% of the maximum pumping requirement. Install and calibrate the pumps according to the manufacturer's recommendations.

3.4 Keypad and Display

The DR5000 ORP Controller menu allows the user to input all the variables necessary to customize the controller for the application. The keypad is used for all programming.

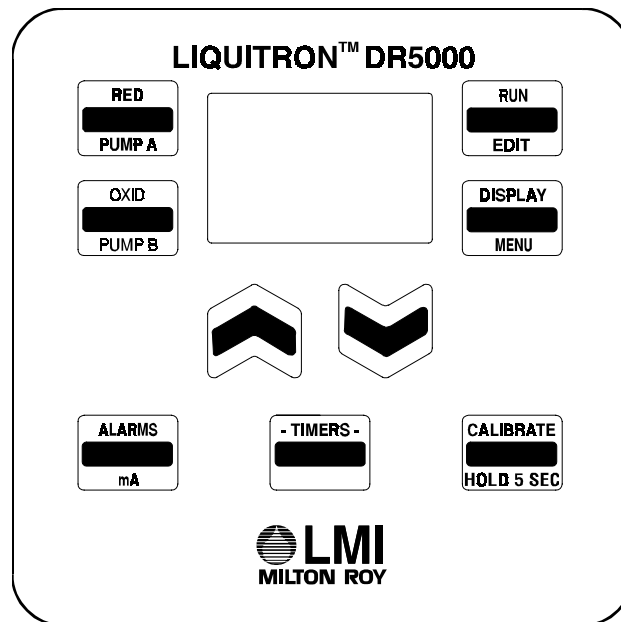

Figure 7: Keypad

KEYS:



This key is used to set up the control profile for the reducer dosing pump (holding the key for five (5) seconds will allow priming of Pump A) (Factory setting 90 SPM).



This key is used to set up the control profile for the oxidizer dosing pump (holding the key for five (5) seconds will allow priming of Pump B) (Factory setting 65 SPM).



This key is used to program the high and low alarm points and hysteresis (**On/Off** mode). It also allows programming of the optional mA output when installed.



This key is used to program 'run times' for Pumps A and B, 'delay times' 1 and 2 for actuating and controlling a solenoid valve (when programmed **On** in the advanced features menu). This key also allows setting of the controller response rate D. If pump run time is over 11:01 hours, the run time is disabled, the pump will not be stopped and will run continuously.

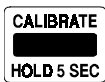

This key when pressed will display details of the last successful electrode calibration (holding the key for five (5) seconds will allow entry into a new calibration procedure [single or two point]).



Pressing this key will cause the display to alternate showing various settings (holding the key for five (5) seconds will allow entry to the 'advanced features' menu).

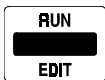

This key is used for starting and stopping (run or edit) the pumps and changing set points in the controller. It changes the mode of the controller from **Run** to **Off**.



or



These keys are used to change values on the display.



+



Simultaneously pressing these two keys will lock the keypad to prevent casual tampering. Pressing them a second time will unlock the keypad. Wait five (5) seconds between locking and unlocking.

4.0 OPERATION

In the default mode, as shipped from the factory without any extended features programmed in the 'menu', the controller is set to operate two dosing pumps towards a single desired ORP region as defined by the set points. It will do this in one of two ways, **On/Off** or **Proportional**, shown graphically below:

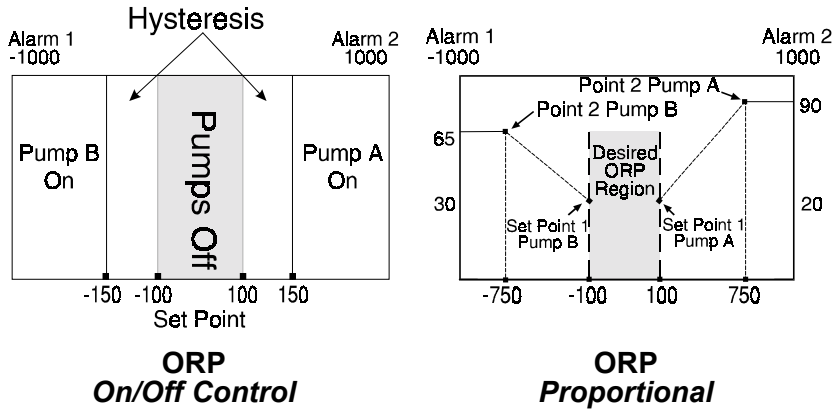

When the unit is plugged in, the computer powers up and the display illuminates. The display flashes the ORP reading and **Off**. This indicates the pumps will not operate and the unit is in the **Off** mode. When the  key is pressed the controller starts and switches into the **Run** mode.

EXAMPLE:

(Proportional Controller)

This display shows a ORP value of 900. Pump A is flashing indicating that the reducer pump is in operation. The pump will stop pumping after 46:35 minutes and alarm will activate if set point is not reached.

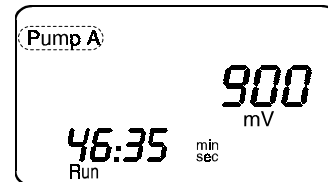

For two (2) seconds in every eight (8) seconds the display shows pump speed in pulses/minute. The pulses/min displayed relates to the pump that is in operation.

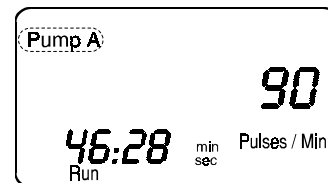

When the ORP value exceeds the programmed ORP alarm point, the ALARM flashes and the alarm relay is activated.

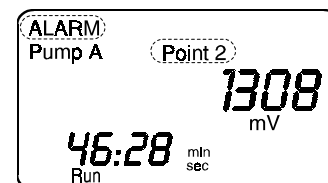

Throughout this manual, the term 'pulse' is used to describe the mechanical stroke of the pump, as 'strokes per minute' (SPM).

4.1 Proportional Mode

The unit is shipped pre set at the factory for the **Proportional** or **On/Off** mode. To change the unit to the opposite mode see ‘Advanced List,’ Option 2, on page 20.







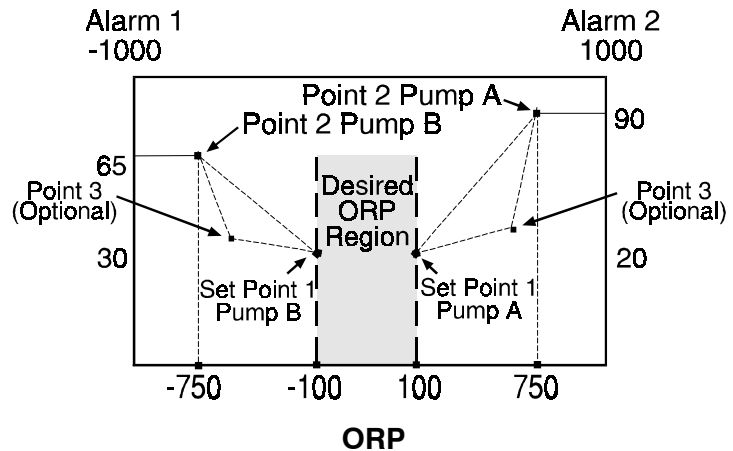





Pump A Control Profile



Controller must be in **Off** mode to program changes.



Pressing  switches the mode back and forth from **Run** to **Off**. The ORP set points and pump speed (pulses/min) can be changed only in the **Off** mode.

- (1) Press  to display current settings.
- (2) Press  or  to increase/decrease the ORP value of Set Point 1 for turning on ‘Pump A.’
- (3) Press  again to advance to next Pump A setting.
- (4) Press  or  to increase/decrease the pump speed (pulse/min) for Pump A at ORP Set Point 1.
- (5) Press  again. This changes to data for Set Point 2 for Pump A.
- (6) Press  or  to increase/decrease the ORP for Set Point 2.
- (7) Press  again to advance to next setting.
- (8) Press  or  to increase/decrease pump speed (pulse/min) for Set Point 2.

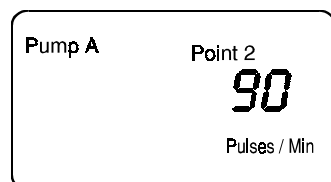
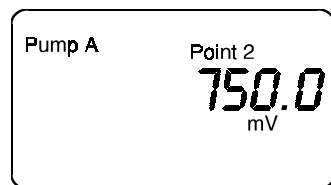
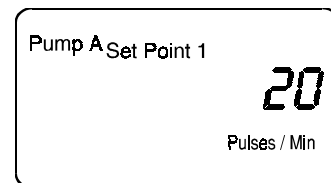
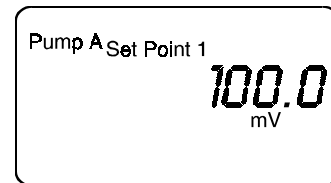

(9) Pump B (Oxidizer Pump) is programmed in a similar way.



If 'Point 3' is selected in the Advanced Features menu, the user will be prompted to enter a ORP value for Set Point 3 and a Pump Speed at Set Point 3.

4.2 On / Off Mode





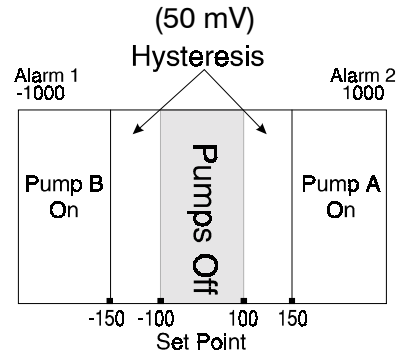

Pump A Control Profile

For **On/Off** Controllers with relay outputs (instead of pulse outputs) each pump is programmed as follows:



Controller must be in **Off** mode to program changes



- (1) Press  to view Pump A settings.
- (2) Press  or  to increase/decrease ORP Set Point.
- (3) Press  again to advance to next Pump A settings.
- (4) Press  or  to program D (Hysteresis) ORP period for relay. In this example, Pump A will turn on at a ORP of 150.0 mV (set point + D mV). Pump A will turn off when ORP reaches 100 mV.
- (5) Pump B (Oxidizer Pump) is programmed in a similar way.

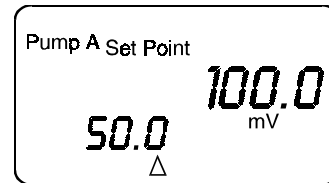
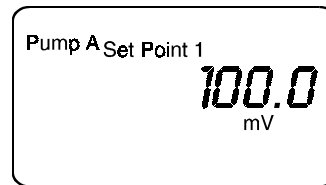

In the example below, Pump B will turn on at a ORP of -150 mV (Set Point - D ORP) and will turn off when ORP reaches 100 mV.

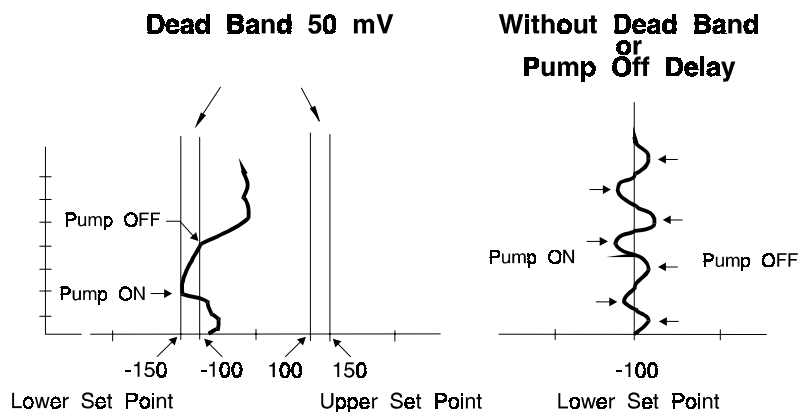

It is highly recommended that the hysteresis (pump off function) be used to prevent relay chatter.



The function of the hysteresis is to prevent pump relay chattering. It operates by allowing the pump to be turned on when the control point plus (or minus) the hysteresis value has been met, but does not allow the pump to turn off until the control point has been met. The chosen value will be used for both upper and lower set points.

The hysteresis, or dead band, designates how many ORP units beyond set point the pump runs before turning off. Any value from 0 to 100 mV is acceptable. If use of this function is undesirable, set it to 0.

4.3 Alarms

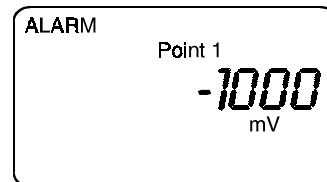

(1) Press  to view Alarm settings.



(2) Press  or  to program Alarm Point 1 (low alarm).
(pump B)

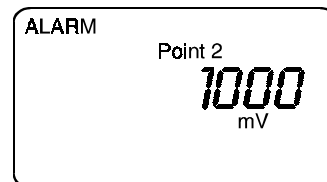

(3) Press  again to save settings and to advance to next Alarm set point.

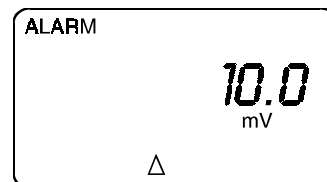

(4) Press  or  to program Alarm Point 2 (high alarm).
(pump A)

(5) Press  again to save data and to advance to hysteresis setting.



(6) Press  or  to program Alarm Hysteresis value. This is the point where the alarm turns off.

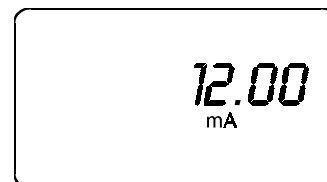

If the 4-20 mA option board is installed, the following screens will appear. If these do not appear and the 4-20 mA PCB is installed, go to Section 4.6, Advanced Menu, and program option "7" to "1" and option "6" to "1".

(7) Press  again to display current mA value.

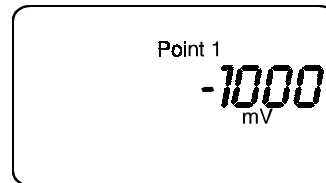

(8) Press  again to program the 4-20 mA output for Point 1.



(9) Press  or  to select the mV value for Point 1 mA output. Default is:

4 mA = - 1000 mV
20 mA = +1000 mV

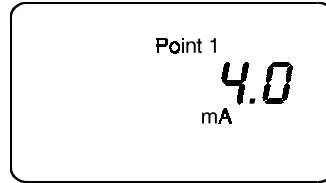

(10) Press  again. Press  or  to select the mA value at Point 1.

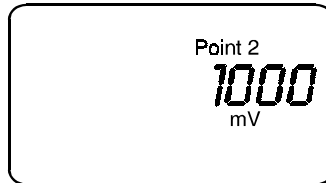

(11) Press  again. Press  or  to select the mV value for Point 2 mA output.

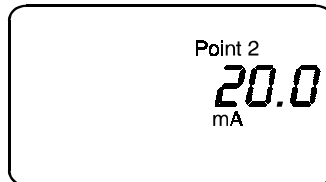

(12) Press  again. Press  or  to select the mA value at Point 2.

4.4 Calibration (Viewing Last Calibration Data)

(1) Press the  key once.

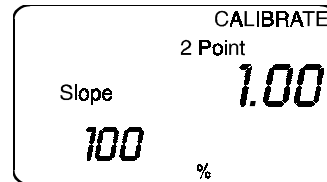

CALIBRATE will be visible and the ‘mV/ORP’ and ‘%’ (slope) of the last successful calibration will be displayed.

‘1 Point’ indicates that the previous calibration was a one point calibration.

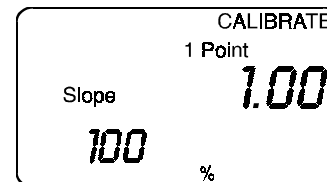

4.5 Performing a New Calibration

For two point calibration, the default settings are Buffer 1 = 80.0 mV and Buffer 2 = 400 mV; but these values may be changed.

The calibration parameters (buffer mV and one or two point calibration) of the previous calibration are the initial values for the current calibration.



The unit must be placed in the **Off** mode. The unit cannot be calibrated in the **Run** mode.



Calibration (e.g., 2 Point)

- (1) Press  + 5 seconds.

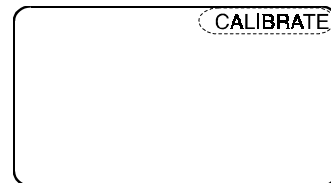
Hold the 'Calibrate' key down for five (5) seconds.
Calibrate will start flashing.



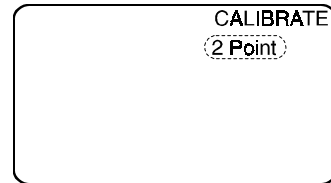

- (2) Press  again.

'2 Point' will start flashing. Use the  or  keys to toggle between '1 Point' and '2 Point.'



- (3) Press  again.

The 'Buffer 1' value will start flashing. Use  or  keys to program Buffer 1 mV value.

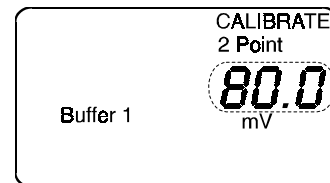



- (4) Press  again.

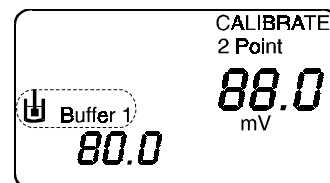

The  symbol will prompt you to put the probe in Buffer 1. Wait for the mV value to settle.



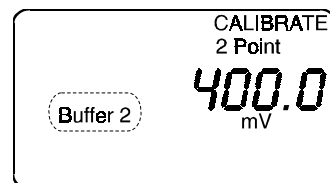

- (5) Press  again.

This will accept the first calibration value and will display the Buffer 2 mV. Use  or  keys to program Buffer 2 (or leave) as desired.



(6) Press  again and the  symbol will prompt you to put the probe in Buffer 2. Wait for the mV value to settle.

(7) Press  again. This will accept the second calibration value and will display the mV/mV and % Slope result of the calibration.

(8) Press  again to accept this calibration and exit calibration mode.

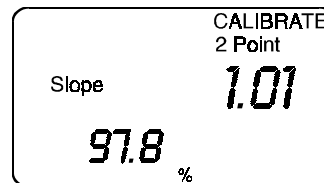
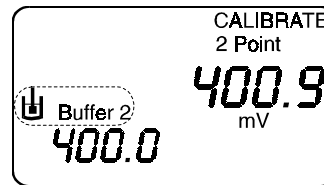

Press any other key to abort calibration.



For a single point calibration, only one buffer is used. The theoretical value for 0.0 mV is used to complete the Calibration Curve.

If the calibration is unsuccessful (slope < 70% or offset > ± 100 mV) and **Error Calibrate** and **E7** are displayed; the calibration should be repeated or else the controller reverts to using the 'last successful' calibration performed.

A slope of less than 70% indicates a dirty/faulty probe or contaminated buffer.

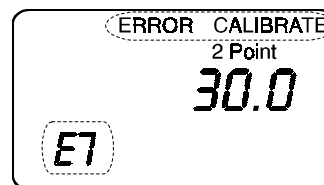

4.6 Pump Timers and Solenoid Pump Valve Control Timers

It is not possible to change timer values while in **Run** mode. Unit must be in the **Off** mode to change values and settings.

Pump Run Time:

This timer is set to the maximum time the pump can be on. If the timer is set to over 11:01 hours, the timer is disabled. This timer is started when a pump is **On** and the ORP value is outside the set points. The controller will stop the pumps when the time reaches '0' and activate **Alarms**. The run time is reset each time the ORP enters the desired set point region.

Solenoid Delay Pump Valve Time:

The Solenoid Valve Relay output may be activated when the ORP is within the set points for the time specified by 'Delay 1.' This may be used for system integration and for emptying a batch tank, etc.

The 'Delay 1' Timer defines the period to allow ORP and system parameters to settle.

The 'Delay 2' Timer (**On** time) defines how long the valve will stay open. When these Delay Timers are active, pump dosing cannot take place but the DR5000 will monitor the ORP. The 'Delay 2' timer starts when the outputs are activated. If the ORP drifts outside of the set point and range, the solenoid relay will be deactivated.



If a 'Delay 2' time goes below one hour, then the display will change to 'minutes : seconds' from 'hours : minutes.'

Setting Timers



The unit must be in the **Off** (edit) mode to change the timer settings.

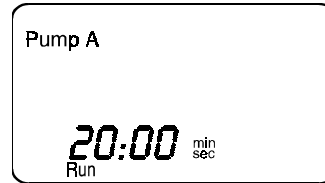

(1) Press the  key to view the run time for Pump A.

(2) Use  or  to adjust to desired maximum run time.



The 'hr : min' will change to 'min : sec' automatically as the run time is reduced below 1 hour.

(3) Press the  key to advance to run time for Pump B.

(4) Use  or  to adjust to desired maximum run time.

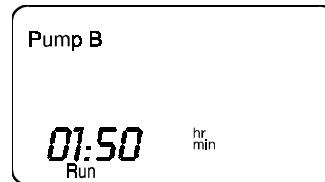



The 'hr : min' will change to 'min : sec' automatically as the run time is reduced below 1 hour.

Delay Timers are factory set in the deactivated mode. The 'Delay 1 and Delay 2' Timers are activated/deactivated in the 'Advanced Features Menu.' These screens will not display when the delay option is deactivated.

Solenoid Valve Control

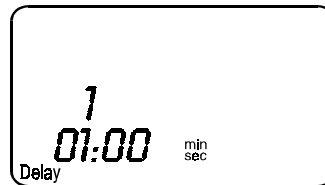
(5) Press the  key to advance to 'Delay 1' time (if activated). 'Delay 1' is the wait time after ORP enters the desired region, before the Solenoid is activated.



(6) Press the  key to advance to 'Delay 2' time (if activated). 'Delay 2' is the Solenoid **On** time.

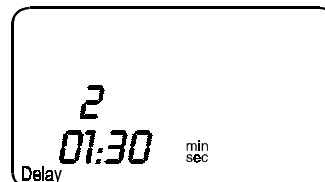

If the ORP should go out of the desired range during 'Delay1' or 'Delay 2', the Solenoid cycle will terminate. It will start again from zero when ORP re-enters the desired region. If ORP remains in the desired region, the controller will enter **Off** mode at the end of the Solenoid **On** time. The controller turns **On** again in one minute and the cycle repeats.

(7) Press  key to advance to **Response Rate**. This is programmed in D ORP units.

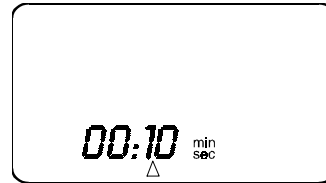

The smoothing of the input signal is determined by D ORP time.

The following values can be programmed (min : sec):
00 : 01, 00 : 10, 00 : 20,.....04 : 00 (In increments of 10 seconds)

When 00 : 01 is programmed the controller responds to a change in input in one (1) second.

If 00 : 10 is selected the controller responds to a change in input in ten seconds. (i.e., the value displayed is the average of the 10 previous 1 second readings.)

Examples: The sampling time (delta) is 00 : 10 and the current reading is 20.00 mV. When the ORP input is increased instantaneously to 120.00 mV, the display will respond as follows:

Seconds	0	1	2	3	4	5	6	7	8	9	10	11
ORP (mV)	20	30	40	50	60	70	80	90	100	110	120	120

If the sampling was 00 : 01 seconds, the response would be:

Seconds	0	1	2	3	4	5	6	7	8	9	10	11
ORP (mV)	2	120	120	120	120	120	120	120	120	120	120	120

Display Key:

While in the **Run** mode the  key can be pressed once to display current parameters. Each screen will come up for three (3) seconds and then returns to ORP or System Run display automatically (screens shown are: i.e., mV, mA).

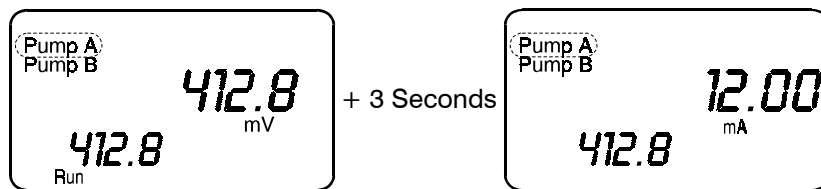

Similarly, the Pump Control Points are consecutively displayed in the **Run** mode by pressing the ‘Pump A’ or ‘Pump B’ keys once.

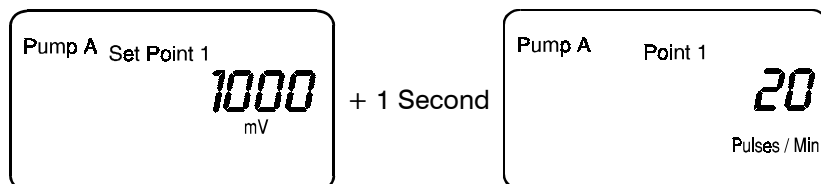

4.7 Advanced Menu List

Holding the  key for five (5) seconds allows programming of **Advanced Features** in a Menu. The menu can be accessed by pressing the **Display/Menu** key for five (5) seconds while the controller is in the **Edit** or **Off** mode.

The first item displayed is the software revision. Pressing **Display/Menu** again cycles to the first option. The first number is the option. The second is the setting. Use the  or  to change the setting.

Option	Setting	
1	1 0	Control returns to Run 60 seconds after last keypress Run/Edit key is On/Off
2	1 0 2	On/Off Control Proportional Control (and On/Off) Proportional Control
3	1 0	Point 3 Programming Enabled Point 3 Programming Disabled (Two point only)
4	1 0	Solenoid programmed to switch on after programmed time Delay 1 and to switch Off after programmed time Delay 2 Solenoid Disabled
5	1 0	Communications Enabled - Option Board must be fitted Communications Disabled
6	1 0	mA Enabled - Option Board must be fitted mA Disabled
7	1 0	Allows editing of #5 & #6 Lockout #5 and #6



The Option Board (34310) is required for Options 5 and 6.

5.0 Maintenance

5.1 ORP Electrode and Cable

The most frequently replaced part is the ORP electrode, which will deteriorate with age. Refillable electrodes should be checked for level frequently, and replenished with filling solution as necessary. An electrode may also fail because of:

- aging (slow response to changing ORP)
- coatings over the glass bulb (slow response to changing ORP)
- abrasion of the glass bulb (shift in calibration)
- chemical attack
- breakage

If you experience instability or lack of response, check the electrode, replace if necessary and recalibrate. Follow manufacturer's recommendation for cleaning the electrode. Take care not to damage input cables, or allow the connections to get wet.

6.0 Troubleshooting

6.1 Error Messages

Troubleshooting and repair of the malfunctioning unit should only be attempted by qualified personnel using caution to ensure safety and limit unnecessary damage.

Should an error or alarm condition occur, the controller will alert the operator to this by flashing an **Error Message**. These messages are depicted below with a brief explanation.

E 1

E1 = LOW LEVEL SWITCH

E 2

E2 = FLOW SWITCH

E 3

E3 = ALARM 1: LOW ORP (PUMP B)

E 4

E4 = ALARM 2: HIGH ORP (PUMP A)

E 5

E5 = Pump B 'LOCKOUT TIMER'

E 6

E6 = Pump A 'LOCKOUT TIMER'

E 7

E7 = CALIBRATION ERROR

E 9

E9 = FAULTY/DISCONNECTED PROBE



Turn system off to clear error message.

7.0 DR5000 Specifications

Power Requirements _____	115 VAC ±15%, 60 Hz 230 VAC ±15%, 50 Hz Voltage input selectable via a selector switch located on the I/O PCB.
Inputs _____	Flow Switch, Remote On/Off , Spares. All low voltage inputs active low, i.e., the active state is when the switch is closed. The switch must be capable of switching 2 mA at ±15VDC.
Outputs _____	Pulse Pump A and B, Alarm. All low voltage outputs capable of switching 2 mA at +24 VDC. The pulse output frequency range will be 0-100 per minute. The pulse output active low. The pulse width 100 ms in the active low) state.
Output Type _____	Opto-Isolated NPN transistor open collector configuration.
Keypad _____	Nine key membrane keypad with tactile response. (The switches are multiplexed 3 x 3.)
Material:	Polyester with a hard coat finish
Actuation Force:	2.6 N to 3.3 N
Travel:	0.65 mm
Termination Connector:	6-way gold plated Berg clincher type 65801-035
ORP Probe Input _____	±0.1 mV (500M W probe ambient cycle 0° F to 113° F (0° C to 45° C)
Accuracy:	0.1 mV
Resolution:	-2000 to 2000 mV
Input ORP Range:	
Input Impedance	10 ¹³ W
Differential:	
Input Impedance	10 ¹⁶ W
Common:	700 V
ESD Protection:	
Relays _____	Fuse protected
Alarm Relays (2):	Electromechanical
Solenoid Valve Relay (1):	115/230 VAC, 10A/6A
Current/Voltage Rating:	10A, 115 VAC or 6A, 230 VAC
Contact Type:	Normally open and normally closed contacts (FORM C) Change over relay 1
Pump On/Off Relay (2):	15V/230VAC, 10A/6A (NO)
(On/Off CONTROL):	On/Off Relays are Fuse Protected (FORM C). Normally open relay
Fuse:	4A, 250 VAC time delay (Anti-surge)

LCD Display _____	
Operating Voltage:	5 V
Operating Temperature	32° F to +122° F (0° C to + 50° C)
Viewing Area:	1.2 x 1.8 inches (30.5 mm x 45.7 mm)
Backlight:	An 8 emitter (dual LED type), double row, reflective backed, backlight module will be used. The light output color and reflective backing color will be high performance green.
Memory Backup _____	EEPROM
Data Retention No Power:	10 years minimum
Light Output Area:	1.2 x 1.8 inches (30.5 mm x 45.7 mm)
Pre-amplifier	
Output Voltages _____	
Voltage:	±5 V
Output Voltage Tolerance:	±5% maximum
Current Output:	±10 mA maximum
Computer	
Communications _____ (NA)	
4-20 mA Load:	500 Ohms maximum resistance
Accuracy:	±0.2 mA . The 4-20 mA shares a common ground with +15 V and the low voltage inputs.
Control Outputs	
(Pump A / Pump B)	Opto-Isolated Open Collector (2 mA)
(Proportional Control)	
Fault:	Opto-Isolated Open Collector (2 mA)
Control Inputs	
Remote On / Off:	Opto-Isolated (2 mA)
Flow Switch:	Opto-Isolated (2 mA)
Low Level Input:	Opto-Isolated (2 mA)
Aux (spare):	Opto-Isolated (2 mA)
Environmental _____	Printed Circuit Boards conformally coated
Operating Temperature:	32° F to 122° F (0° C to 50° C)
Enclosure:	IEC IP65, NEMA 4X - Hardwired IEC IP, NEMA 12X
Mechanical _____	Two printed circuit boards (3 if option installed)
Control Board:	(Microcontroller & Display) - Low Voltage
Terminal/Power board:	Transformer, fuses, terminal blocks, relays
Option Board:	(4-20 mA output) - Low Voltage

8.0 Parts List

Key No.	Part No.	Description
1	34691	Housing, Machined
2	32186	Screw, 4-40 x .37
3	32187	Nut, 4-40 Flush
4	32209	Latch, Machined
5	34270	I/O Board Assembly
6	34716	Standoff, Self Adhesive
7	31632	Screw, #6 x .38
8	34329	BNC Cable Assembly
9	34330	Ribbon Cable Assembly
10	25957-1	Cord Clamp (PG-9 clamp for female outlet power cord)
11	36810	Dowel
12	31571	Clamp, Cord (PG-9 clamp for 4-pin cable)
13	34074	Gasket, Foam
14	34088	Cover, Utility Box
15	30588	Label, LMI Logo
16	37526	Front Panel Assembly
17	31617	Cover, Liquitron™
18	32094	Label, Housing cover LMI
19	32211	Cap, .125 x .38
20	32352	O-Ring, Sponge
21	32395	Screw, Self-Tapping
22	34911	Cover, Fuse
23	35711	Cord, Power, 115V, NEMA 15-R - DR5000-XA (On/Off)
	33636	4-Pin Cable - DR5000-XB (Proportional)
24	34930	Terminal Cover Label
25	34315	Circuit Board Support
26	30749	Power Cord 115 V - DR5000-1A/B
	30751	Power Cord 220 V US - DR5000-2A/B
	30752	Power Cord DIN - DR5000-3A/B
	34783	Cord Assembly UK - DR5000-5A/B
	30754	Power Cord AUST - DR5000-6A/B
	34784	Cord Assembly SWISS - DR5000-7A/B
27	34310	4-20 mA Circuit Board Assembly
28	35712	Fuse, 4 Amp

9.0 Exploded View

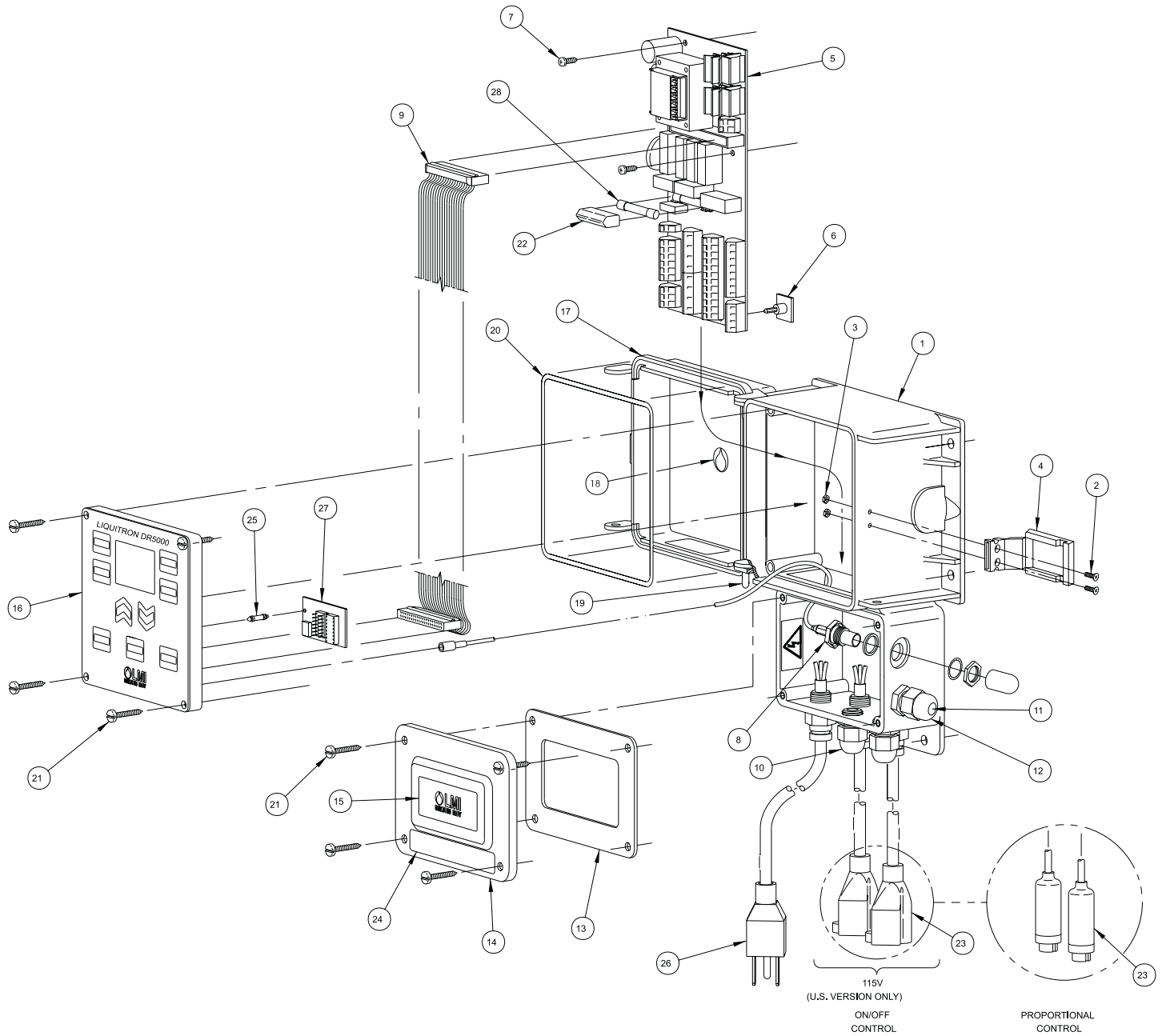

10.0 Program Log

For record keeping, a program log is provided below.

	Proportional		On/Off	Proportional		On/Off
	Pt 1	Pt 2		Pt 1	Pt 2	
Pump A Set Point	100	750	100			
Pump A Pulses/Min	20	90	///			///
Pump B Set Point	-100	-750	-100			
Pump B Pulses/Min	30	65	///			///

Hysteresis 1	///	///	50	///	///	
Hysteresis 2	///	///	50	///	///	

	Alarms	Alarms
Alarm 1	-1000 mV	mV
Alarm 2	1000 mV	mV
Hysteresis	10 mV	mV

	mA Response	mA Response
Current Low	4.0 mA	mA
Signal Low	-1000 mV	mV
Current High	20.0 mA	mA
Signal High	1000 mV	mV

	Timers	Timers
Pump A On-Time	20:00 Min	
Pump B On-Time	30:00 Min	
Sampling Time	00:10 Min	

Delay to Solenoid ON	5:00 Min	
Solenoid On-Time	20:00 Min	

	Calibration	Calibration
Number of Points	2	
Buffer 1	80.0	
Buffer 2	400.0	

11.0 Statement of Limited Warranty

LMI TERMS AND CONDITIONS OF SALE:

1. Seller warrants that the equipment delivered by it to the Buyer is in accordance with the Seller's published specifications and is of the kind and of the description contained in seller's invoice.

THIS WARRANTY IS IN LIEU OF AND TO THE EXCEPTION OF ALL OTHER WARRANTIES, EXPRESS OR IMPLIED, INCLUDING BUT NOT BY WAY OF LIMITATION, WARRANTIES OF MERCHANTABILITY OR FITNESS FOR A PARTICULAR PURPOSE. DISTRIBUTOR IS NOT AUTHORIZED TO BIND THE COMPANY FOR ANY OTHER WARRANTY. THE FOREGOING STATES THE COMPANY'S ENTIRE AND EXCLUSIVE LIABILITY, AND DISTRIBUTOR AGREES TO HOLD THE COMPANY HARMLESS FROM AN IMPROPER APPLICATION OF PRODUCTS.

2. Seller's liability for breach of the foregoing warranty is expressly limited to the repair or, at Seller's option, replacement of such equipment FOB factory, or Acton, MA. Such obligation to repair or replace such equipment shall terminate 12 months after the delivery to such equipment to the Buyer. In no event shall the Seller be liable for any consequential damages resulting from any breach of warranty.

The Company warrants the Products in accordance with the statement of warranty policy included herein except that pump Product series designated as "A," "B," "C," "E" and "P" and Liquitron™ series of product shall be warranted for a period of two (2) years from the date of delivery from Company; and except replacement elastomeric expendable parts and probes which are not covered by any warranty either express or implied.

If the Buyer claims that the warranty contained herein has been breached, it shall immediately notify the Seller of such claimed breach in writing at Seller's address contained herein. The Buyer shall render necessary assistance to Seller, and it shall furnish adequate means for operating and testing such equipment.

The SOLE PURPOSE of the foregoing stipulated exclusive remedy shall be to provide to the Buyer free repair or at Seller's option replacement of non-conforming equipment in the manner provided herein. This EXCLUSIVE REMEDY shall not be deemed to have failed of its essential purpose so long as the Seller is willing and able to repair or at its option replace non-conforming equipment in the prescribed manner.

3. Seller shall not be liable for any loss or damage for delays in delivery or compliance with any warranty provision contained herein due to acts of God, acts of civil or military authorities, fires, floods, wars, riots, labor strikes or actions, accidents or delays in transportation or any other cause beyond the Seller's control.

4. All Shipments by Company to Distributor shall be made F.O.B. Factory, Acton, Massachusetts 01720, U.S.A. unless special arrangements are agreed to by both Company and Distributor.

5. The within terms and conditions constitute the entire agreement of the Buyer and Seller. Such terms and conditions may not be modified, altered or amended except by a writing signed by both parties. Such terms and conditions shall be binding upon the parties hereto, their successors and assigns. In the event that any term or condition shall be held to be invalid or unenforceable, all other terms shall remain in full force and effect. Such terms and conditions shall be governed and construed in accordance with the laws of the Commonwealth of Massachusetts.



8 Post Office Square
Acton, MA 01720 USA
TEL: (978) 263-9800
FAX: (978) 264-9172
<http://www.lmipumps.com>



© 1999 LMI Milton Roy - All Rights Reserved
Printed in USA
Specifications subject to change without notice.

Liquitron is a trademark of Liquid Metronics, Inc.